

OWNER'S MANUAL

BLUE GENIUS™ TOUCH CONTROL MASTER CONTROL PANELS



ACTUAL PRODUCT MAY NOT APPEAR EXACTLY AS SHOWN



WARNING

Do not operate or service this product unless you have read and fully understand the entire contents of this manual. Failure to do so may result in property damage, bodily injury or death.

BLUE GIANT®

TABLE OF CONTENTS

1.0	ABOUT BLUE GENIUS™ TOUCH CONTROL MASTER CONTROL PANELS	3
1.1	OWNER'S PURCHASE RECORD	3
2.0	INTRODUCTION	4
2.1	WARRANTY INFORMATION	4
2.2	EXCLUSION OF LIABILITY	4
2.3	MANUFACTURER'S NOTE	4
2.4	OWNER'S RESPONSIBILITY	5
3.0	SAFETY MESSAGE COLOR IDENTIFICATION	6
3.1	OPERATIONAL SAFETY WARNINGS	6
4.0	LOCKOUT / TAGOUT PROCEDURE AND RULES	7
4.1	ROTARY DISCONNECT: PLATINUM SERIES	7
5.0	CONTROL PANEL OPERATION: GOLD SERIES III	8
5.1	BUTTON FUNCTION: GOLD SERIES III	8
5.2	CONTROL SECTIONS: GOLD SERIES III	9
6.0	RECOMMENDED SPARE PARTS: GOLD SERIES III	10
7.0	EQUIPMENT COMPONENT ILLUSTRATIONS: GOLD SERIES III	11
7.1	COMPONENTS AS SHIPPED CHECK LIST: GOLD SERIES III	11
7.2	MECHANICAL ASSEMBLY: GOLD SERIES III	12
7.3	GENERAL DIMENSIONS: GOLD SERIES III	13
8.0	CONTROL PANEL OPERATION: PLATINUM SERIES	14
8.1	BUTTON FUNCTION: PLATINUM SERIES	14
8.2	CONTROL SECTIONS: PLATINUM SERIES	15
9.0	RECOMMENDED SPARE PARTS: PLATINUM SERIES	17
10.0	EQUIPMENT COMPONENT ILLUSTRATIONS: PLATINUM SERIES	18
10.1	COMPONENTS AS SHIPPED: PLATINUM SERIES	18
10.2	MECHANICAL ASSEMBLY: PLATINUM SERIES	19
10.3	GENERAL DIMENSIONS: PLATINUM SERIES	21
11.0	DECAL IDENTIFICATION AND LOCATION: GOLD SERIES III AND PLATINUM SERIES	22
12.0	STOP PROCEDURE: GOLD SERIES III AND PLATINUM SERIES	23
13.0	OPERATING INSTRUCTIONS: GOLD SERIES III AND PLATINUM SERIES	24
13.1	ALTERNATIVE METHODS OF OPERATION: GOLD SERIES III AND PLATINUM SERIES	25
14.0	ENGAGING THE OVERRIDE FEATURE: GOLD SERIES III AND PLATINUM SERIES	26
14.1	RELEASING THE OVERRIDE FEATURE: GOLD SERIES III AND PLATINUM SERIES	27
15.0	EXTERIOR TRAFFIC LIGHT / MIRROR IMAGE SIGN: GOLD SERIES III AND PLATINUM SERIES	28
16.0	CONTROL PANEL LCD MESSAGES: GOLD SERIES III AND PLATINUM SERIES	29
17.0	WIRING DIAGRAMS: GOLD SERIES III AND PLATINUM SERIES	29
17.1	WIRING DIAGRAM - 115V SINGLE PHASE: GOLD SERIES III (SVR303 & FH COMBO)	30
17.2	WIRING DIAGRAM - 230V SINGLE PHASE: GOLD SERIES III (TL85 REMOTE & FH COMBO)	31
17.3	POWER WIRING DIAGRAM - 230 - 575V THREE PHASE: PLATINUM SERIES (SVR303 & VL COMBO)	32
17.4	CONTROL WIRING DIAGRAM - 230 - 575V THREE PHASE: PLATINUM SERIES (SVR303 & VL COMBO)	34

1.0 ABOUT BLUE GENIUS™ TOUCH CONTROL MASTER CONTROL PANELS



Blue Genius™ Touch Control Master Control Panels (MCP) represent the highest level in loading dock safety and productivity.

The Master Control Panels consolidate the controls for multiple interconnected dock devices:

- Dock leveler
- Vehicle restraint
- Overhead door (standard with Platinum Series, optional with Gold Series)
- Inflatable seal (standard with Platinum Series, optional with Gold Series)
- Dock lights (standard with Platinum Series, optional with Gold Series)
- Communications - Traffic lights (trailer and forklift) and LCD menu screen

The equipment operation sequence is structured to ensure safety and efficiency. The LCD menu screen provides ongoing equipment status as well as instructions for operating and troubleshooting. The interior and exterior LED light communication system displays safety signals to truck drivers and dock personnel. The rotary disconnect (Platinum Series only) cuts power to the unit for routine servicing and maintenance.

The panel's NEMA4X-rated polycarbonate enclosure is wet and corrosion-resistant, ensuring seamless operation in the wash-down zone and outdoor locations. The control panels are also compatible with operations that must adhere to the FDA's high cleaning standards, such as pharmaceutical and chemical handling locations.

LEGEND	
	Section applies only to Blue Genius™ Gold Series III
	Section applies only to Blue Genius™ Platinum Series
	Section applies to both Blue Genius™ control panels

1.1 OWNER'S PURCHASE RECORD

OWNER'S PURCHASE RECORD	
Please record information for future inquiries and to validate warranty. (See Section 2.1 for warranty validation)	
Dealer:	Date in Service:
	Number of Units:
Gold Series III <input type="checkbox"/> Platinum Series <input type="checkbox"/>	
Serial Number:	Door #:
Serial Number:	Door #:
Serial Number:	Door #:
Serial Number:	Door #:

The manufacturer offers a full line of dock levelers, dock safety equipment, accessories, ergonomic and scissor lift equipment, seals and shelters, and industrial trucks. Concurrent with a continuing product improvement program, specifications are subject to change without notice (see Section 2.2 "Exclusion of Liability" of this manual). Please contact the manufacturer for latest information. Some features illustrated may be optional in certain market areas.

NOTICE
See Section 11.0 "Decal Identification and Location: Gold Series III and Platinum Series," item #3 for serial number location.

2.0 INTRODUCTION

The following is a quick reference to important procedures that must be followed while using the MCP. It is not intended to cover, or suggest that it does cover, all procedures necessary to ensure safe operation. All operators should be aware of and abide by all workplace safety regulations applicable to the operation of the MCP. These laws and regulations include but are not limited to:

- The Occupational Safety and Health Act
- Canada Occupational Health and Safety Regulations
- Occupational Safety and Health Acts for Individual States (USA)

For additional information on these regulations as well as industry standards that may apply to this product, please contact:



American National Standards Institute (ANSI)
 1430 Broadway
 New York, NY 10018
 Telephone: 212.642.4900
www.ansi.org

Also a member of:



Loading Dock Equipment Manufacturers
 A Product Section of Material Handling Industry of America
 A Division of Material Handling Industry
 8720 Red Oak Blvd, Suite 201
 Charlotte, NC, 28217-3992
 Telephone: 704.676.1190
www.mhi.org/lodem

2.1 WARRANTY INFORMATION

Thank you for purchasing Blue Giant products. We appreciate your business, and are confident that our product will serve you for many years to come. In the event that you experience a problem with our product, our Warranty Center is here to support the Blue Giant product(s) that you have purchased.

To validate warranty on recently purchased equipment, please complete and submit your information with our online Warranty Registration at www.BlueGiant.com.

For more information about Blue Giant Warranty Support, please contact your local Blue Giant Equipment dealer, representative or authorized partner near you. You may also visit www.BlueGiant.com or phone 1.905.457.3900.

DEALER INFORMATION

Name:

Contact:

Telephone:

* **NOTE** that failure to validate warranty at the time of receipt can seriously affect the outcome of any claim.

2.2 EXCLUSION OF LIABILITY

The manufacturer assumes no liability for damage or injury to persons or property which occur as a result of defects or faults in or incorrect use of the control panel. The manufacturer also assumes no liability for lost profits, operating downtimes, or similar indirect losses incurred by the purchaser. Injury to third parties, irrespective of its nature, is not subject to compensation.

The manufacturer reserves the right to make changes at any time to the modules, components, and accessories, concurrent with its continuing product improvements and development program. Specifications, operating instructions, and illustrations included in this manual are subject to change without notice. Please contact manufacturer for the latest information.

2.3 MANUFACTURER'S NOTE

The control panel has been carefully inspected and tested at the manufacturer's plant prior to shipment, but should be checked upon receipt for transport damage. Any observed transport damage is to be listed on the signed copy of the freight document. Notify the freight forwarder of any damage WITHIN 48 HOURS.



2.4 OWNER'S RESPONSIBILITY

1. The owner should recognize the inherent danger of the interface between the dock and the freight carrier. The owner should, therefore, train and instruct operators in the safe use of the dock equipment and accessories in accordance with the manufacturer's recommendations.
2. The owner should thoroughly familiarize themselves with the following procedures and specifications, and request immediate replacement of all manufacturer-supplied documents that are missing, damaged, or otherwise illegible. Below is a list of Best Practices for dock equipment usage and maintenance.
 - Commissioning instructions
 - Operating instructions
 - Daily maintenance procedures checklist
 - Inspections procedures
 - Recommended spare parts lists

Upon receipt of any newly purchased dock equipment, the owner shall verify the presence of owner's manuals, operating placards, and any other documentation necessary for training dock personnel how to use the equipment safely and effectively.
3. All Blue Giant dock equipment should undergo regularly scheduled planned maintenance. Maintenance requirements will vary according to usage frequency and application, so the owner shall consult with their authorized Blue Giant distributor for schedule recommendation. Written records of the performance of these procedures should be kept as per warranty requirements.
4. Dock equipment that is structurally damaged, experiencing performance irregularities, or has been potentially compromised shall be removed from service until a trained and authorized manufacturer's representative can conduct an inspection and perform any necessary repairs.
5. As with any piece of machinery, dock equipment requires routine maintenance, lubrication, and adjustments. Recommended procedures are itemized in the Planned Maintenance Program (PMP) checklist included in installation and technical manuals. It is recommended that for anything other than the basic maintenance procedures outlined in this manual, you contact your local Blue Giant representative.
6. The owner shall ensure that all name plates and safety labels are in place and legible, and that the appropriate manuals are provided to authorized users. Replacement name plates, safety labels, and manuals are available through the Blue Giant Aftermarket Department. See "Decal Identification and Location" section in this manual for more information.
7. The owner or a trained and authorized representative shall verify that all freight carrier brakes have been applied and a vehicle restraint and/or wheel chocks properly engaged before cross-docking procedures begin. For safety reasons trailers must be held securely in place to avoid accidental separation from the loading dock.
8. Unless specifically agreed to in writing by Blue Giant Equipment Corporation at the time of order (and prior to manufacture), all Blue Giant Dock equipment is sold as a complete offering and must not be altered or added to in any manner (which includes configuration and function) without written permission from an authorized manufacturer's representative. These changes shall also satisfy all safety recommendations of the original equipment manufacturer for the particular application of the dock equipment.
9. If, at the request of the owner, Blue Giant does not supply all or some of the dock equipment power unit and/or control panel components, the owner shall assume responsibility for any and all operational and safety issues associated with the resulting configuration.

3.0 SAFETY MESSAGE COLOR IDENTIFICATION

This manual includes color-coded safety messages that clarify instructions and specify areas where potential hazard exists. To prevent the possibility of equipment damage and serious injury or death, please observe strictly the instructions and warnings contained in the messages. If warning decals become damaged or missing, replace them immediately. Avoid accidents by recognizing dangerous procedures or situations before they occur.

 DANGER	NOTICE
Serious injury or death will likely occur if the instructions are not followed.	Procedures marked notice must be followed in order to prevent damage to machinery.
 WARNING	 CAUTION
Serious injury or death may occur if the instructions are not followed.	Instructions marked caution concern safe operating procedure. Failure to comply may result in personal injury.

3.1 OPERATIONAL SAFETY WARNINGS

 DANGER
<ol style="list-style-type: none"> 1. Do not operate the dock equipment while anyone is standing in its path. 2. Lift the dock equipment with suitable hoisting equipment only. Do not stand under the dock equipment or any heavy object while it is being hoisted. 3. BEFORE BEGINNING ANY SERVICE PROCEDURES: Disconnect the power and follow all lockout / tagout procedures outlined in this manual.

 WARNING
<ol style="list-style-type: none"> 1. Installation must be performed only by trained and authorized personnel. 2. Prior to installation, place adequate barriers to prevent vehicle traffic from entering the work area. 3. Any electrical work must be performed by qualified personnel only. 4. Do not remove the wheel chocks until loading / unloading is finished and the truck is cleared for departure or the vehicle restraint has been released and the lights have changed to RED inside and GREEN outside.

NOTICE
<ol style="list-style-type: none"> 1. Do not ground welding equipment to any electrical components. 2. Do not allow the drill to go too deeply into the control box, as damage may occur to the control systems. 3. Never use air to blow debris from the control box. Use a vacuum to perform any necessary cleaning. 4. Do not connect green ground lead into control box or junction box until all welding has been completed.

 CAUTION
<ol style="list-style-type: none"> 1. Only trained personnel should operate or service this equipment. 2. Do not operate the dock equipment until the transport vehicle is parked against the dock bumpers. 3. Always park the dock equipment after use (ensure that the lip is safely parked in the lip keepers). 4. Conduct routine inspections and maintenance. Failure to do so could cause equipment damage and or personal injury. 5. Always call your authorized service representative or manufacturer immediately if a malfunction occurs. 6. Always return the restraint arm to the parked position after use.

! WARNING

Always lockout and tagout any power source before performing any work on any electrical devices or electrical controls according to OSHA regulations and approved local electrical codes.

4.0 LOCKOUT / TAGOUT PROCEDURE AND RULES

In accordance with the rules and regulations of the Occupational Safety and Health Administration (OSHA), all affected employees must be notified that the machine or equipment will be shut down and locked out to perform repair or maintenance work. The work area must be checked to ensure that all personnel have been removed or safely repositioned. The machine or equipment power supply shall be locked in the OFF position or disconnected from the energy source. Blue Giant strongly recommends that only OSHA-approved lockout devices and procedures be utilized.

The energy isolating device must bear a prominent warning tag indicating that work is being done on the equipment and the name of the authorized employee responsible for the lockout. It is mandatory that tagout notices not be susceptible to deterioration or illegibility due to weather conditions or exposure to chemicals and moisture.

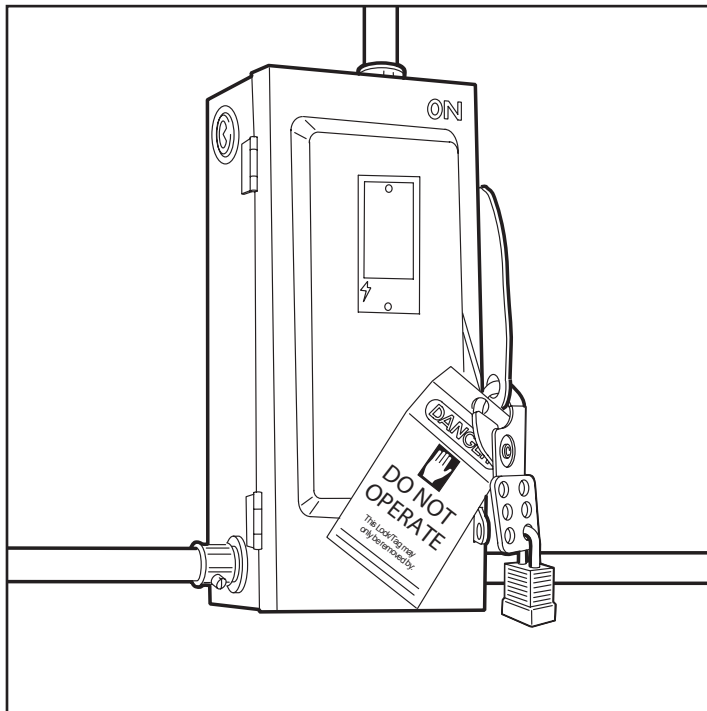

Approved way to lockout / tagout.

4.1 ROTARY DISCONNECT: PLATINUM SERIES

The Platinum Series has a built-in rotary disconnect. The disconnect has two switch positions: ON and OFF, and can be locked in either position.

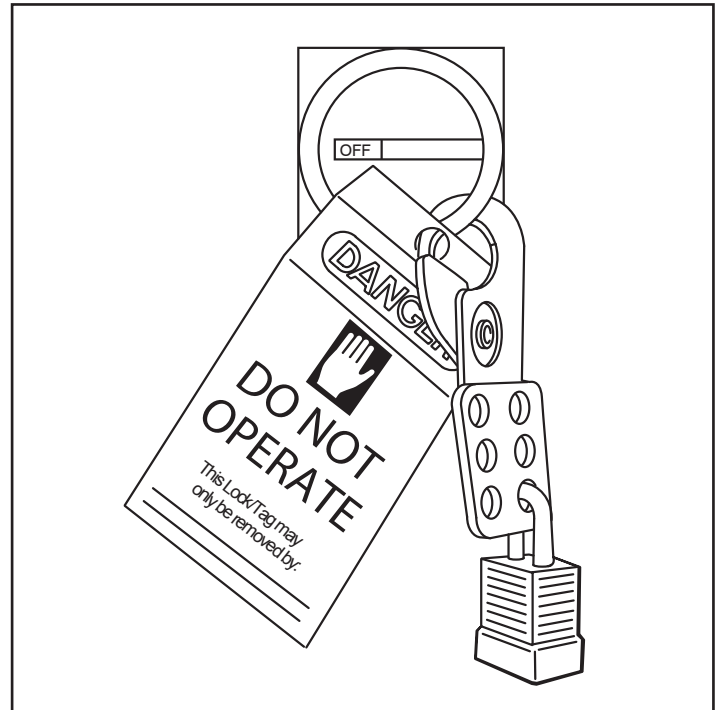

Approved way to lockout / tagout.

5.0 CONTROL PANEL OPERATION: GOLD SERIES III

Controls combinations of all supported dock equipment: one individual vehicle restraint, one individual dock leveler, and controls for a door. Also equipped with touch buttons, inside forklift operator traffic lights, operator menu screen, and keypad for coded features.

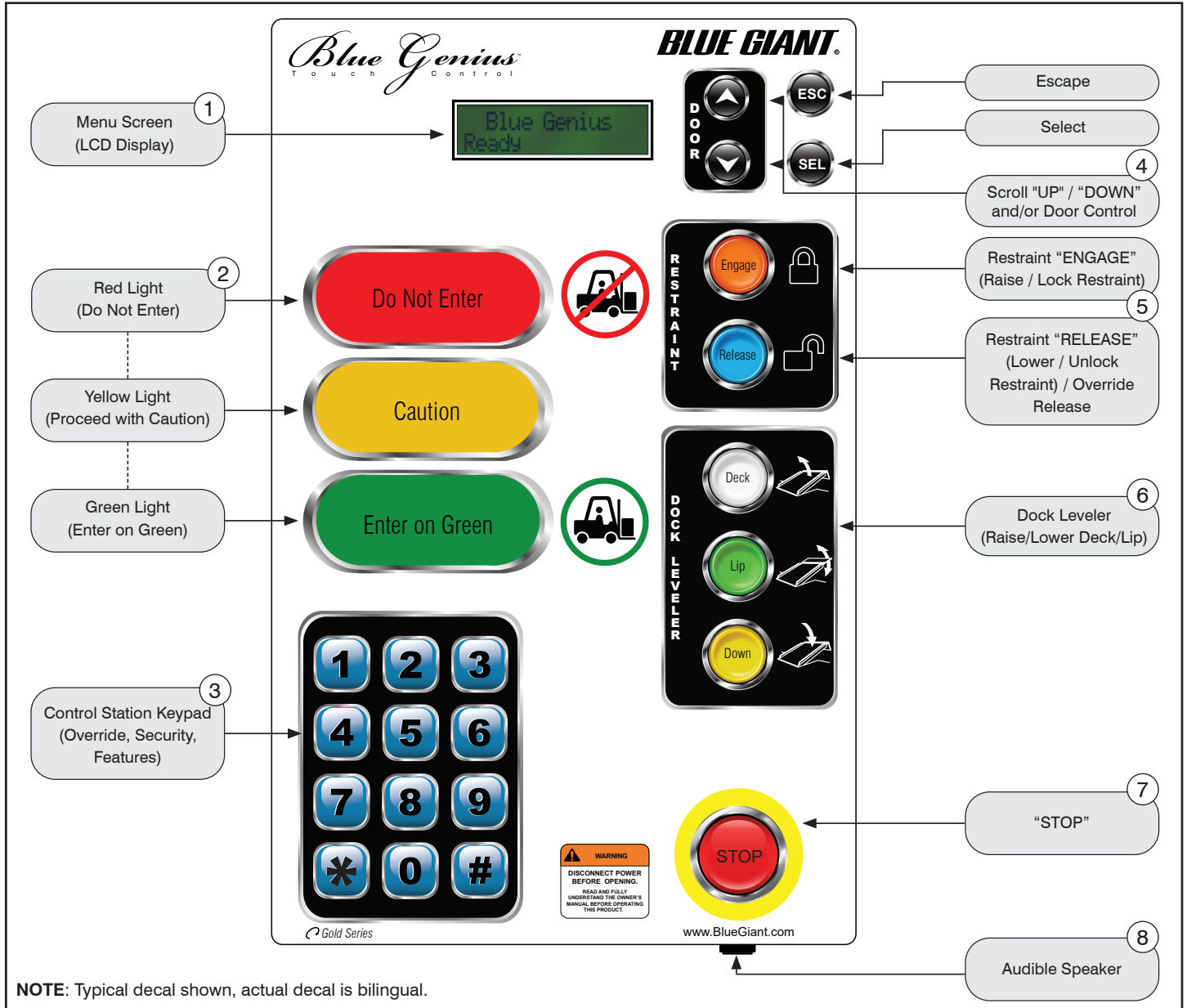

5.1 BUTTON FUNCTION: GOLD SERIES III

When touching any of the function buttons or keypad, use the pad of the finger. The control panel's unique touch sensors detect the proximity of the dock operator's finger. Audible touch buttons and keypad on the control panel provide instant sound feedback to user input.



5.2 CONTROL SECTIONS: GOLD SERIES III

This section explains the function of each button on the Gold Series III. General operating instructions for all connected dock equipment appear in the following section.

- ①  **MENU SCREEN (LCD DISPLAY):**
Displays digital instructions for the operating and troubleshooting of all connected dock equipment.
- ②  **FORKLIFT TRAFFIC LIGHTS:**
RED: The connection between the dock and trailer is not yet secure.
YELLOW: Caution. Restraint is bypassed or ready to end load when flashing.
GREEN: The connection between the dock and trailer is secure. Also confirms that the leveler is released from home and may be engaged to trailer.
- ③  **CONTROL PANEL KEYPAD:**
Enables code-based security features such as vehicle restraint bypass.
- ④  **DOOR CONTROL:**
OPEN: Opens the overhead door when the door is not programmed to open automatically when the restraint is engaged.
CLOSE: Lowers the overhead door. Must be held.
 * If Equipped
- ⑤  **RESTRAINT:**
ENGAGE: Begins the engagement sequence of the restraint arm / hook.
RELEASE: Disengages the restraint arm / hook.
- ⑥  **DOCK LEVELER:**
DECK: Raises the deck from the deployed or parked position.
LIP: Deploys the deck lip (also parks the deck lip of vertical storing dock levelers).
DOWN: Lowers the deck (vertical storing dock levelers only) or lowers the Door and Dock Guard via bypass mode (XDS only).
 † VL Vertical Storing Dock Leveler and XDS only.
- ⑦  **STOP:**
Halts or limits the motion of all interlocked equipment and door.
- ⑧  **AUDIBLE SPEAKER:**
Brings safety issues to dock attendant's attention.
Emits sound when "Audible touch" buttons are pressed.

6.0 RECOMMENDED SPARE PARTS: GOLD SERIES III

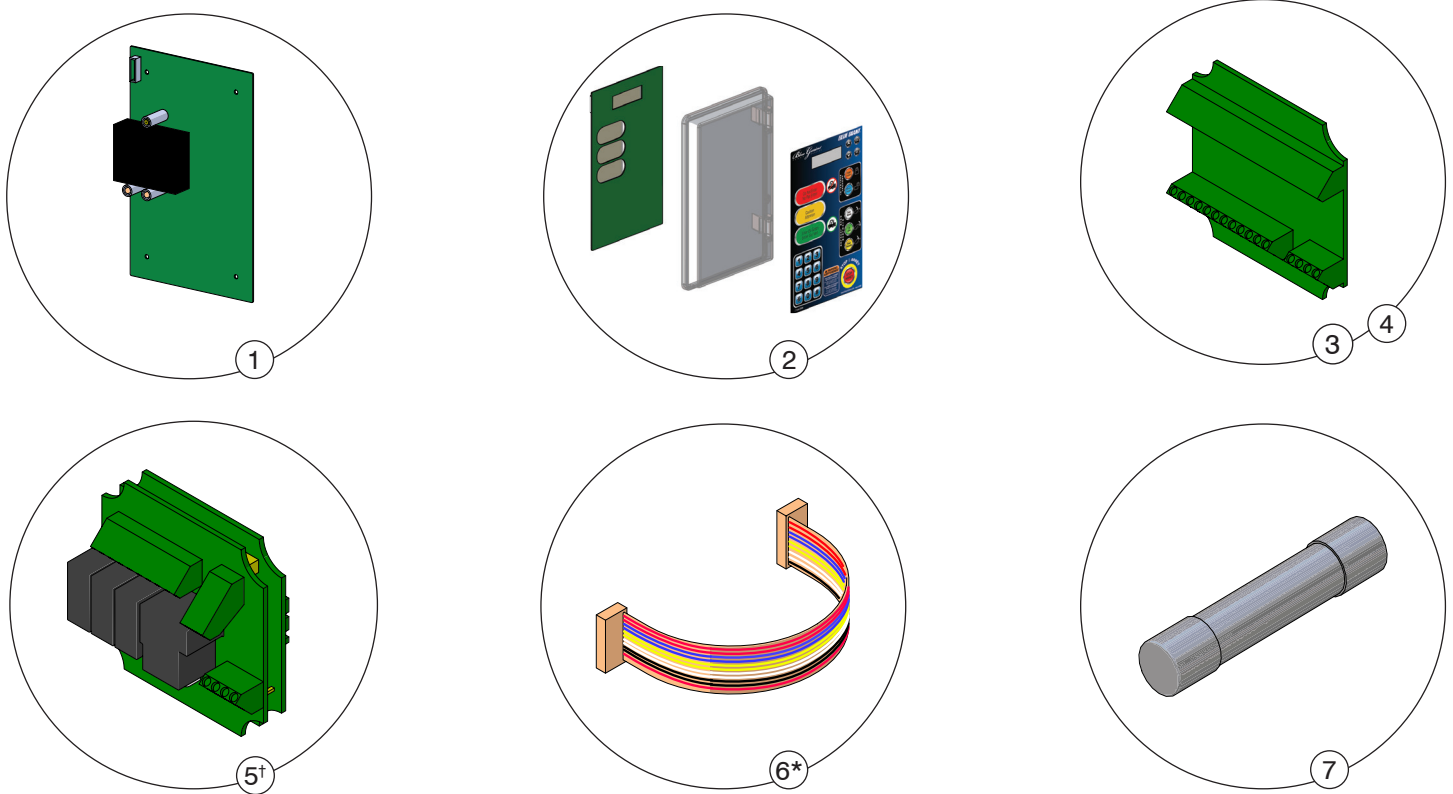

STANDARD OPERATIONAL COMPONENTS			
ITEM	PART NO.	DESCRIPTION	QTY. REQ'D
SINGLE PHASE			
1	026-PB1115	Power Board Sub-assembly (1PH 115V 50-60HZ)	1
	026-PB1230	Power Board Sub-assembly (1PH 230V 50-60HZ)	
THREE PHASE			
1	026-PB3230	Power Board Sub-assembly (3PH 230V 50-60HZ)	1
	026-PB3400	Power Board Sub-assembly (3PH 400V 50-60HZ)	
	026-PB3460	Power Board Sub-assembly (3PH 460V 50-60HZ)	
	026-PB3575	Power Board Sub-assembly (3PH 575V 50-60HZ)	
2	026-G021-99	Control/Touch Board w/LED and LCD Modules	1
	BGG2xxEx-TC	Transparent Cover Door	1
	—	Decal, Part # based on Serial #	1
3	026-G025M	Remote I/O-A Board w/ Resistor	1
4	026-G025BM	Remote I/O-B Board w/o Resistor (for SVR303)	1
5	026-G025-99M	Remote I/O-B Board w/ Door Control	1

STANDARD OPERATIONAL COMPONENTS			
ITEM	PART NO.	DESCRIPTION	QTY. REQ'D
6	026-G030	Ribbon Cable, 16 Wire/Pin w/ Connector	1
7	026-G100	Fuse, 15A, 250V, Slow Blow for 1PH, 110-130V	1
	026-G101	Fuse, 8A, 250V, Slow Blow for 1PH, 208-240V	1
	026-G102	Fuse, 0.5A, 250V Slow Blow for 1 and 3PH, 208-240V	1
	026-G103	Fuse, 0.25A, 250V Slow Blow for 1PH, 208-240V	1
	026-G104	Fuse, 0.75A, 250V Slow Blow for 1PH, 110-130V	1
	026-G105	Fuse, 500mA, 700V, Fast Blow for 3PH, 380-415V	1
	026-G106	Fuse, 400mA, 700V, Fast Blow for 3PH, 440-480V	1
	026-G107	Fuse, 315mA, 700V, Fast Blow for 3PH, 575-600V	1
	026-G123	Fuse, 5A, 250V, Slow Blow for 1PH, 110-130V	1

* Optional † If Equipped

7.0 EQUIPMENT COMPONENT ILLUSTRATIONS: GOLD SERIES III

7.1 COMPONENTS AS SHIPPED CHECK LIST: GOLD SERIES III



✓	ITEM	QTY	PART NO.	DESCRIPTION	APPROX. WEIGHT	
	1	1	Dependent on voltage See Section 7.2	Blue Genius™ Gold Series III Control Panel	10 lb	4.5 kg
	2	1	025-G010-1	Mounting Tabs with hardware (1 pkg. of 4)	—	—
	3	1	038-225	E F S P Exterior Driver Warning Sign	0.7 lb	0.32 kg
	4	1	032-806	Exterior Driver Traffic Light	1.3 lb	0.6 kg
	5	1	038-918	E F S Owner's Manual (this one)	—	—
	6	1	Dependent on model #	E F S Operation Placard(s)	—	—

7.2 MECHANICAL ASSEMBLY: GOLD SERIES III

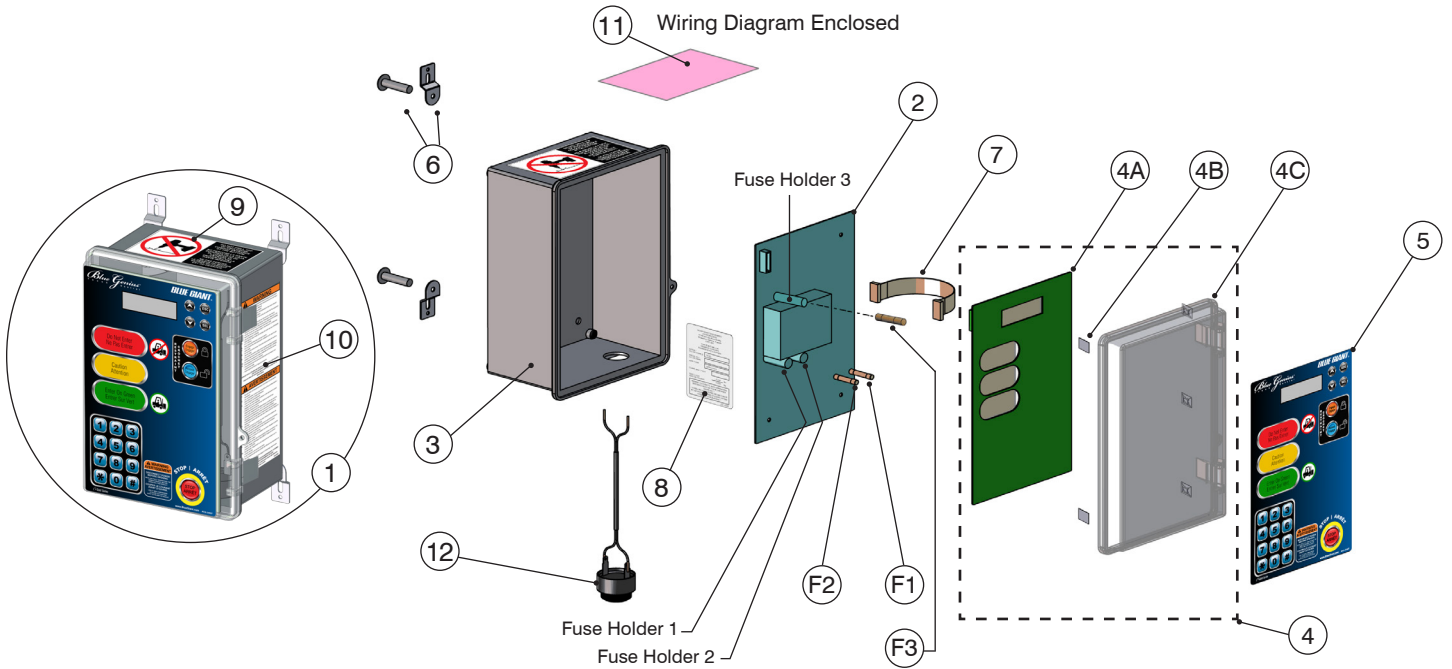

COMPLETE CONTROL STATION ASSEMBLY - ITEM 1 (Example BGGFS1115F)

SINGLE PHASE							
ITEM	◇	FUSE	QTY	PART NO.	DESCRIPTION	ASSY PART #	*
2	F1	A J	1	026-PB1115	Power Board Sub-Assembly † (1PH 115V 50-60HZ)	BGGFS1115	F
	F2	E	1				S
	F1	C	1	026-PB1230	Power Board Sub-Assembly † (1PH 230V 50-60HZ)	BGGFS1230	F
	F2		1				S
	THREE PHASE						
	ITEM	◇	FUSE	QTY	PART NO.	DESCRIPTION	ASSY PART #
2	F1	C	1	026-PB3230	Power Board Sub-Assembly † (3PH 230V 50-60HZ)	BGGFS3230	F
	F2		1				S
	F1	F	1	026-PB3400	Power Board Sub-Assembly † (3PH 400V 50-60HZ)	BGGFS3400	F
	F2		1				S
	F1	G	1	026-PB3460	Power Board Sub-Assembly † (3PH 460V 50-60HZ)	BGGFS3460	F
	F2		1				S
F1	H	1	026-PB3575	Power Board Sub-Assembly † (3PH 575V 60HZ)	BGGFS3575	F	
F2		1				S	
3			1	025-G010-M	Control Box Enclosure (Includes 4C)		
4			1	025-G014-V3-M	Transparent Cover Door (4C) and Touch Control Board (4A) (Serial # Required)		
4A			1	026-G021-M	Touch Control Board (Serial # Required)		
4B			5	025-062	Cable Tie Mount		
4C			1	025-G014	Transparent Cover Door		
5			1	038-XXE	Face Decal (Dependent on Configuration) (Not sold separately)		F
							S

* Language on decal: F = English / French S = English / Spanish

◇ Location on Power Board † Includes Fuses ‡ 115 Volt Control Box Shown

ITEM	QTY	PART NO.	DESCRIPTION
6	1	025-G010-1	Mounting Tabs with Hardware (1 pkg. of 4)
7	1	026-G030	Ribbon Cable
8	1	038-284E	F S
			Decal, Serial Plate (Not sold separately)
9	1	038-283ESF	Decal, Do Not Drill
10	1	038-853E	F S
			Warning Decal
11	1	026-615-1	Anti-Static Poly Bag (Wiring Diagram Enclosed) (Serial # required for diagram)
			026-G402-B
F3	1	026-037-1	Fuse, 2.5A, 700V, Fast-Blow 1/4" Glass

AS PER VOLTAGE - SEE ITEM 1

ITEM	QTY	PART NO.	DESCRIPTION	USE
A	1	026-G100	Fuse, 15A, 250V for 1PH, 110-130V	LEVELER, SVR303
B	1	026-G101	Fuse, 8A, 250V for 1PH, 208-240V	TL85
C	1	026-G102	Fuse, 0.5A, 250V for 1 and 3PH, 208-240V	
D	1	026-G103	Fuse, 0.25A, 250V for 1PH, 208-240V	
E	1	026-G104	Fuse, 0.75A, 250V, for 1PH, 110-130V	
F	1	026-G105	Fuse, 500mA, 700V for 3PH, 380-415V	
G	1	026-G106	Fuse, 400mA, 700V for 3PH, 440-480V	
H	1	026-G107	Fuse, 315mA, 700V for 3PH, 575-600V	
J	1	026-G123	Fuse, 5A, 250V for 1PH 110-130V	HVR303

7.3 GENERAL DIMENSIONS: GOLD SERIES III

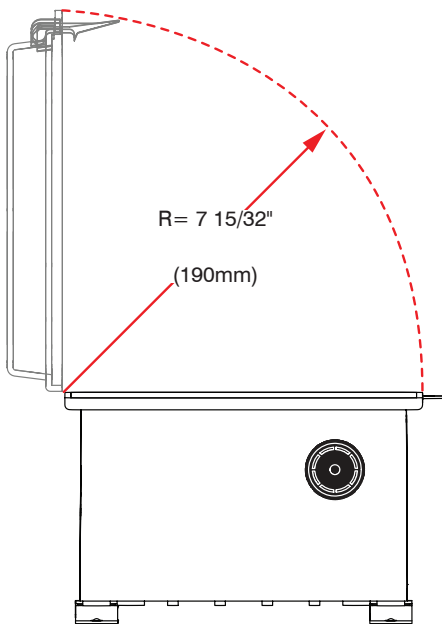
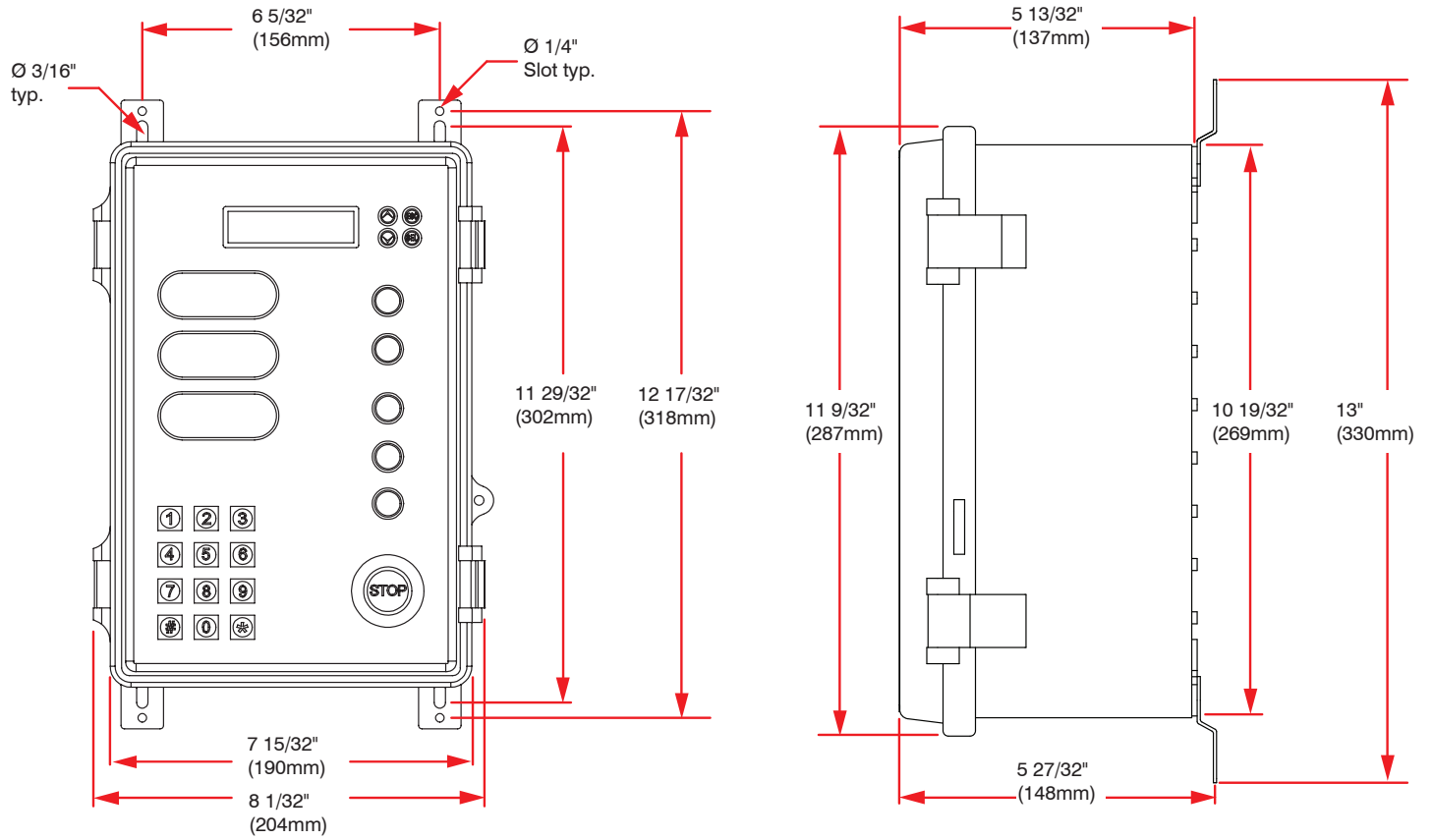

8.0 CONTROL PANEL OPERATION: PLATINUM SERIES

Controls combinations of all supported dock equipment: one individual vehicle restraint, dock leveler, door, inflatable seal, and dock light. Also equipped with touch buttons, inside forklift operator traffic lights, operator menu screen, and keypad for coded features.

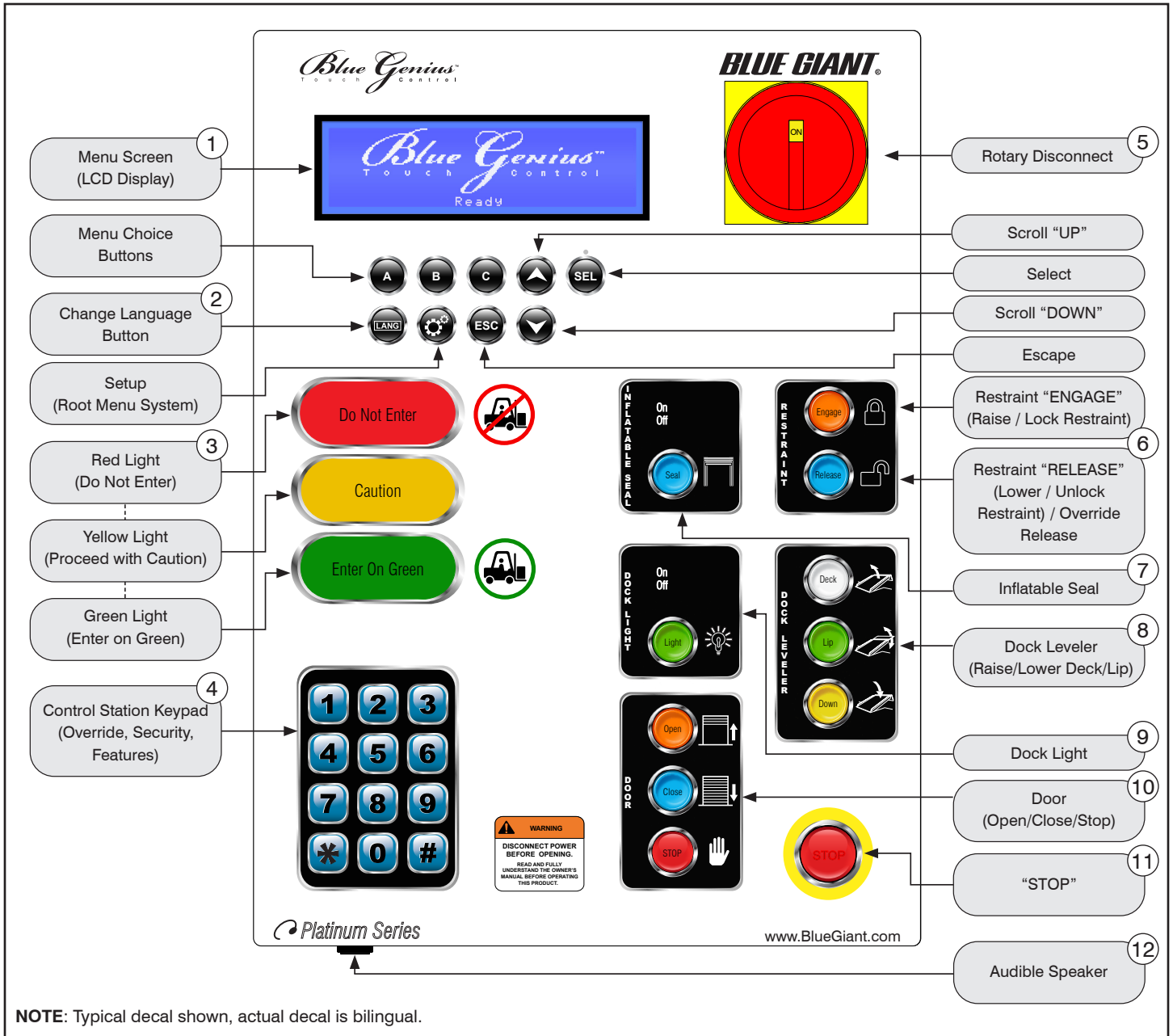

8.1 BUTTON FUNCTION: PLATINUM SERIES

When touching any of the function buttons or keypad, use the pad of the finger. The control panel's unique touch sensors detect the proximity of the dock operator's finger. Audible touch buttons and keypad on the control panel provide instant sound feedback to user input.

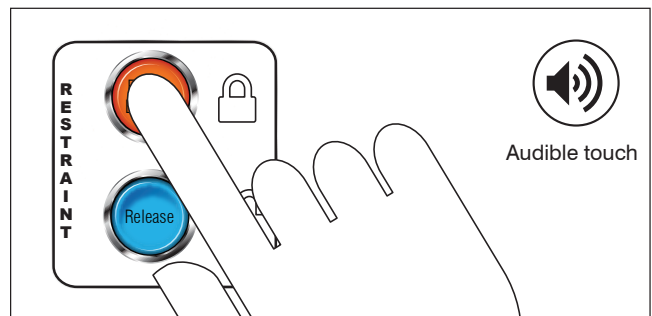

8.2 CONTROL SECTIONS: PLATINUM SERIES

This section explains the function of each button on the Platinum Series. General operating instructions for all connected dock equipment appear in the following section.

- ①  **MENU SCREEN (LCD DISPLAY):**
Displays digital instructions for the operating and troubleshooting of all connected dock equipment.
- ②  **LANGUAGE:**
Changes the LCD display language to English, French, or Spanish.
- ③  **LED CONTROL PANEL LIGHTS:**
RED: Do Not Enter: the connection between the dock and trailer is not yet secure.
YELLOW: Caution. Restraint is bypassed or ready to end load when flashing.
GREEN: Enter: the connection between the dock and trailer is secure.
- ④  **CONTROL STATION KEYPAD:**
Enables code-based security features such as vehicle restraint bypass.
- ⑤  **ROTARY DISCONNECT:**
ON: Locks the control panel enclosure and provides power to the unit.
OFF: Unlocks the control panel enclosure and cuts power to the unit.
- ⑥  **RESTRAINT:**
ENGAGE: Begins the engagement sequence of the restraint arm / hook.
RELEASE: Disengages the restraint arm / hook.
- ⑦  **INFLATABLE SEAL:**
Activates and deactivates the inflatable seal when the seal is not in automatic mode.
- ⑧  **DOCK LEVELER:**
DECK: Raises the deck from the deployed or parked position.
LIP: Deploys the deck lip (also parks the deck lip of vertical storing dock levelers).
DOWN: Lowers the deck (vertical storing dock levelers only) or lowers the Door and Dock Guard via bypass mode (XDS only).

8.2 CONTROL SECTIONS: PLATINUM SERIES CONT'D.



9



DOCK LIGHT:

Activates and deactivates the dock light when the light is not in automatic mode.

10



DOOR:

OPEN: Opens the overhead door when the door is not programmed to open automatically when the restraint is engaged.

CLOSE: Lowers the overhead door. Must be held.

STOP: Stops the door in mid-motion.

11



STOP:

Halts or limits the motion of all interlocked equipment and door.

12



AUDIBLE SPEAKER:

Brings safety issues to dock attendant's attention.

Emits sound when "Audible touch" buttons are pressed.

9.0 RECOMMENDED SPARE PARTS: PLATINUM SERIES

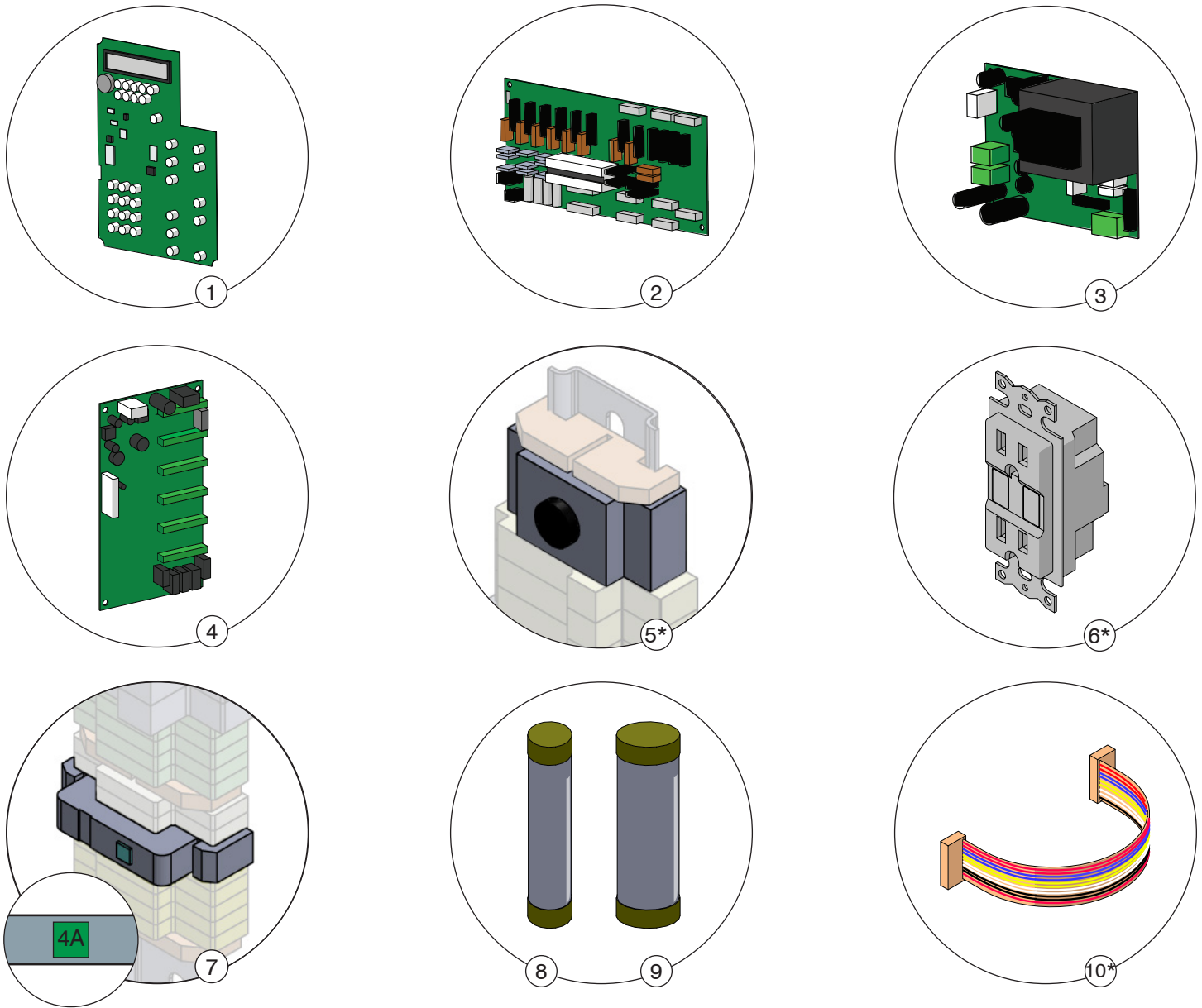

STANDARD OPERATIONAL COMPONENTS			
ITEM	PART NO.	DESCRIPTION	QTY REQ'D
1	026-CB-BGP-1	Control Board Assembly	1
2	026-XXXXXX-BGP	Relay Board Assembly See Section 10.2	1
3	026-PBXXX-BGP	Power Board Assembly See Section 10.2	1
4	026-IO-BGP	PCB, BGP, I/O	1
5	028-588	Disconnect Switch	1

STANDARD OPERATIONAL COMPONENTS			
ITEM	PART NO.	DESCRIPTION	QTY REQ'D
6	028-586	Receptacle GFI	1
7	028-605	4 A Circuit Breaker (Shown)	1
	026-746	15 A Circuit Breaker	
8	See Section 15.2	Fuse Control	—
9	See Section 15.2	Fuse Power	—
10	026-G030	Ribbon Cable (16C)	1

* Optional

10.0 EQUIPMENT COMPONENT ILLUSTRATIONS: PLATINUM SERIES

10.1 COMPONENTS AS SHIPPED CHECK LIST: PLATINUM SERIES



✓	ITEM	QTY	PART NO.	DESCRIPTION	APPROX. WEIGHT	
	1	1	BGP-4-XXXXX-X Dependent on voltage See Section 10.2	Blue Genius™ Platinum Series Control Panel	25 - 35 lb	11 - 16 kg
	2	1	025-G012-1	Mounting Tabs with Hardware (1 pkg. of 4)	—	—
	3	1	038-225	E F S P Exterior Driver Warning Sign	0.7 lb	0.32 kg
	4	1	032-806	Exterior Driver Traffic Light	1.3 lb	0.6 kg
	5	1	038-918	E F S Owner's Manual (this one)	—	—
	6	1	Dependent on model #	E F S Operation Placard(s)	—	—

10.2 MECHANICAL ASSEMBLY: PLATINUM SERIES

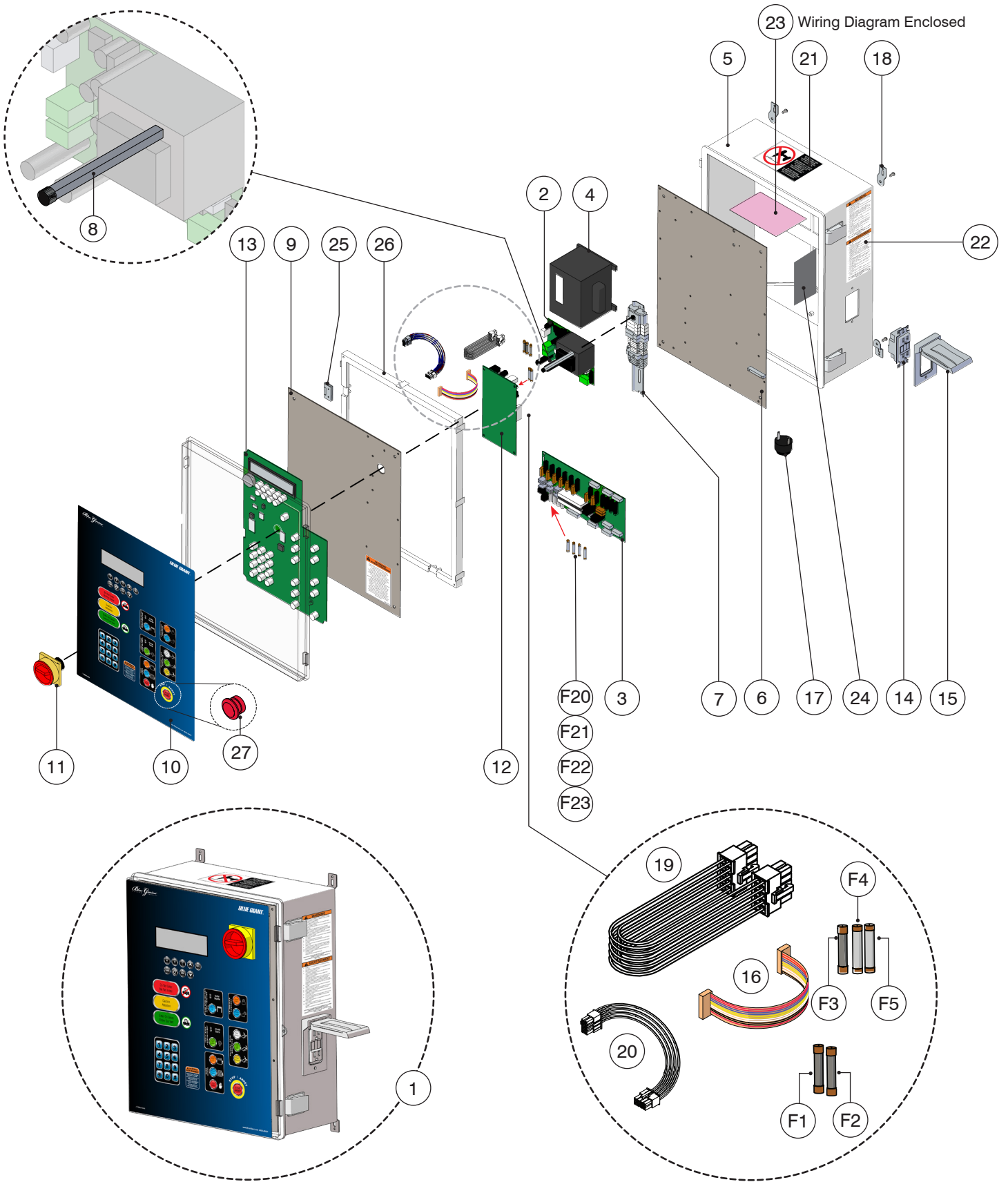

10.2 MECHANICAL ASSEMBLY: PLATINUM SERIES CONT'D.

COMPLETE CONTROL STATION ASSEMBLY - ITEM 1 (Example BGP-4-460-115F)							ITEM	QTY	PART NO.	DESCRIPTION				
2	◇	SINGLE PHASE - POWER BOARD					*	5	1	025-G012-A	Enclosure			
		F1	B	2	026-PB115-BGP	Power Board † Assembly, 115V, 1PH		BGP-4-115	F	025-G030-A	Assembly, Plate, Backing			
		F2	C	3					S					
		F3	D	2	026-PB230-BGP	Power Board † Assembly, 230V, 1PH		BGP-4-230-115	F	025-G035	Assembly, DIN Rail, BGP(4A)			
		F4	C	3					S	025-G036	Assembly, DIN Rail, BGP (15A)			
		THREE PHASE - POWER BOARD						2	8	1	028-592	Shaft, Disconnect		
		F1 F2 F3 F4 F5	D	2	026-PB230-BGP	Power Board † Assembly, 230V, 3PH			BGP-4-230-115	F	025-G031-A	038-400E	Divider Plate	
			C	3						S				Decal, Blue Genius™ Platinum Series * (Not sold separately)
			F	2	026-PB400-BGP	Power Board † Assembly, 400V, 3PH			BGP-4-460-115	F			028-590	
			C	3						S			026-IO-BGP	PCB, BGP, I/O
			C	3	026-PB460-BGP	Power Board † Assembly, 460V, 3PH			BGP-4-460-230	F			026-CB-BGP-1	Control Board Assembly
			F3	G						2			S	028-586
		F4	C	3	026-PB460-BGP	Power Board † Assembly, 460V, 3PH			BGP-4-460-115	F	028-587	Receptacle Cover		
		F5	C	3						S	026-G030	Ribbon Cable		
		E	2	026-PB575-BGP	Power Board † Assembly, 575V, 3PH	BGP-4-575-115			F	026-G402-B	Audible Speaker			
		C	3						S	025-G012-1	Mounting Tabs			
		C	3	026-PB575-BGP	Power Board † Assembly, 575V, 3PH	BGP-4-575-230			F	026-G048-A	Cable Assembly, BGP, I/O-RLY, 28.5," 8Pins			
								S	026-G049-A	Cable Assembly, BGP, PSU-I/O, 13.5," 10Pins				
		SINGLE PHASE - RELAY BOARD						3	21	1	038-283ESF	Decal, Do Not Drill		
		F20	J	4	026-RB1230-BGP	Relay Board Assembly, 115-220V, 1PH			BGP-4-115	F	038-853E	Warning Decal *		
		F21								S				
F22														
F23														
THREE PHASE - RELAY BOARD					3	22	1		026-615-1	Anti-Static Poly Bag (Wiring Diagram Enclosed - Serial # req'd for diagram)				
F20 F21 F22 F23	J	4	026-RB3230-BGP	Relay Board Assembly 220V, 3PH		BGP-4-230-115	F		038-284E	Decal, Serial Plate *				
						BGP-4-460-115	S							
				026-RB3575-BGP		Relay Board Assembly 400-575V, 3PH	BGP-4-460-230			F	AS PER VOLTAGE - SEE ITEM 1			
							BGP-4-460-230			S				
			BGP-4-575-115	F		ITEM	QTY		PART NO.	DESCRIPTION		USE		
			BGP-4-575-230	S		B	1		026-G101	Fuse, 8A, 250V for 1PH, 208-240V		TL85		
						C	1	026-G102	Fuse, 0.5A, 250V for 1 and 3PH, 208-240V					
					D	1	026-237-1	Fuse, 2.5A, 250V, Fast Blow						
					E	1	026-G104	Fuse, 0.75A, 250V, for 1PH, 110-130V						
					F	1	026-G105-SB	Fuse, 500mA, 700V for 3PH, 380-415V						
					G	1	026-G106	Fuse, 400mA, 700V for 3PH, 440-480V						
					H	1	026-G107	Fuse, 315mA, 700V for 3PH, 575-600V						
					J	1	026-G123	Fuse, 5A, 250V for 1PH 110-130V	HVR303					

* Language on decal: F = English / French S = English / Spanish

◇ Location on Power Board † Includes Fuses

10.3 GENERAL DIMENSIONS: PLATINUM SERIES

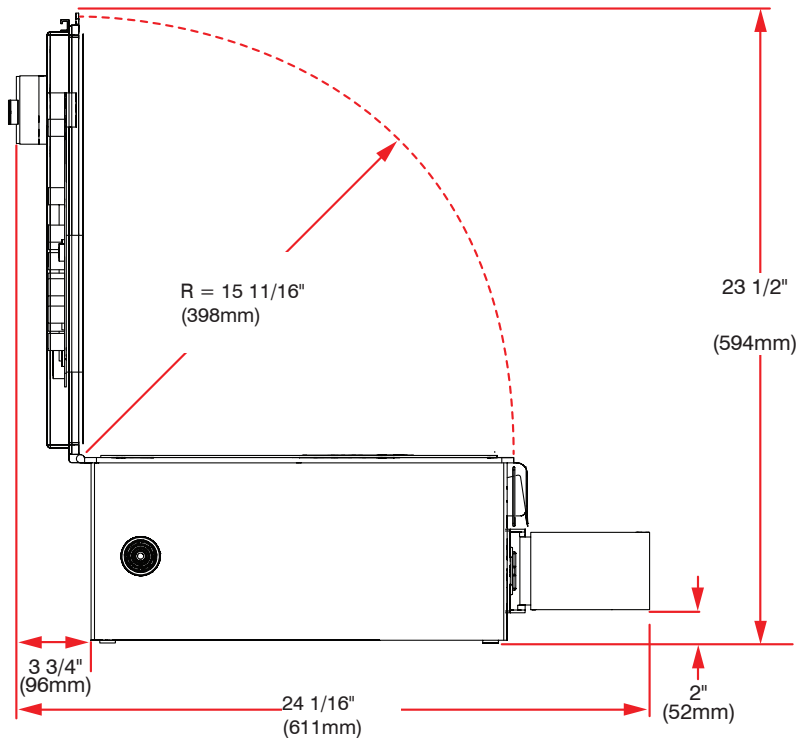
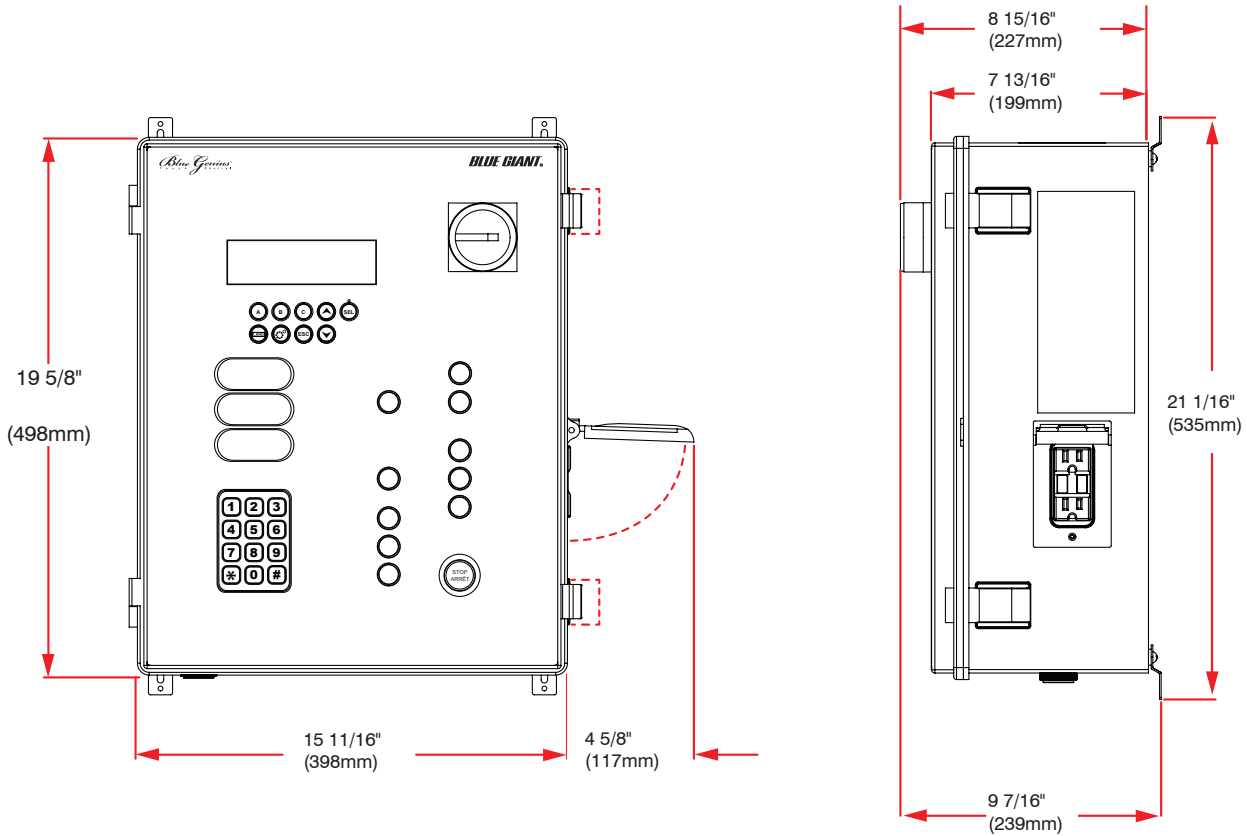

11.0 DECAL IDENTIFICATION AND LOCATION: GOLD SERIES III AND PLATINUM SERIES

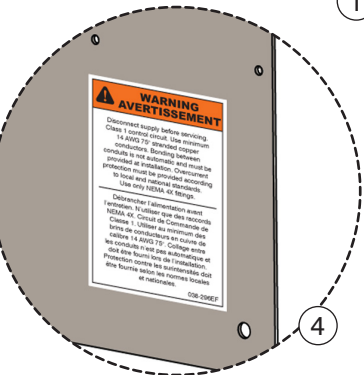

WARNING

- Do not operate this dock equipment without training and authorization.
- Read, understand and follow these instructions and the warnings / instructions in the Owner's Manual.
- Prior to using this dock equipment:
 - Ensure that all personnel, visitors and obstructions have been cleared away from the path of operation.
 - Ensure that all personnel, visitors and obstructions are aware that the equipment will be in use.
 - Operate the equipment through one full cycle to verify that all components are functioning properly. If damage is observed or the equipment malfunctions, notify maintenance personnel immediately and do not use until required repairs have been made.
- Verify that the truck has been properly checked and / or restrained prior to loading or unloading.
- Verify that the dock leveler overlaps the trailer bed by a MINIMUM of 4" (102mm).
- Keep hands and feet clear of all pinch points.
- Do not exceed the rated capacity as indicated on the dock leveler serial plate.
- Do not use the dock leveler if the trailer bed exceeds the leveler's service range.
- If an interior and exterior lights communication package has been installed, load and unload ONLY when the interior light is GREEN. Do not leave equipment or cargo unattended on the dock leveler.
- If maintenance or service is required:
 - Only authorized service personnel shall perform all repairs and maintenance steps.
 - Follow approved lockout / tagout procedures.

APPLIES TO ALL STAND-ONE DOCK LEVELERS, VEHICLE RESTRAINTS, AND DOCK EQUIPMENT COMBOS

Failure to follow the instructions above could result in death and / or serious injury.

AVERTISSEMENT

- Ne pas utiliser cet équipement sans la formation et l'autorisation nécessaires.
- Lire, comprendre et suivre ces instructions et les avertissements / instructions dans le Guide d'utilisation.
- Avant d'utiliser cet équipement:
 - Assurez-vous que tous les personnes, visiteurs et les obstructions soient écartés de la voie d'opération.
 - Assurez-vous que tous le personnel aux alentours sachent que l'équipement sera en service.
 - Faites passer l'équipement complètement pour vérifier que tous les composants fonctionnent bien. Si y a de l'endommagement ou l'équipement est défectueux, avertir le personnel d'entretien immédiatement et ne pas utiliser l'unité avant qu'elle soit réparée.
- Vérifier que le camion soit bien et correctement chargé sur le plateau du camion par AU MOINS 4" (102mm).
- Garder les mains et les pieds loin de tous les points de pincement.
- Ne pas dépasser la capacité nominale indiquée sur la plaque signalétique du niveleur de quai.
- Ne pas utiliser le niveleur si le plateau de communication et extérieur est installé, charger et décharger SEULEMENT lorsque la lumière intérieure est VERTE.
- Si un système de verrouillage et d'étiquetage approuvés.
- Ne pas laisser l'équipement ou la charge sans surveillance sur le niveau de quai.
- Si de l'entretien ou du service est requis:
 - Seul du personnel de service autorisé doit effectuer les réparations et l'entretien.
 - Suivre les procédures de verrouillage et d'étiquetage approuvées.

S'APPLIQUE À TOUS NIVELEURS DE QUAI INDEPENDANTS, SYSTEMES DE RETENUE, ET COMBOS EQUIPMENTS DE QUAI.

Refuse de suivre les instructions ci-dessus peut causer des blessures graves et/ou la mort.

ATTACHED TO DIVIDER PLATE IN PLATINUM SERIES

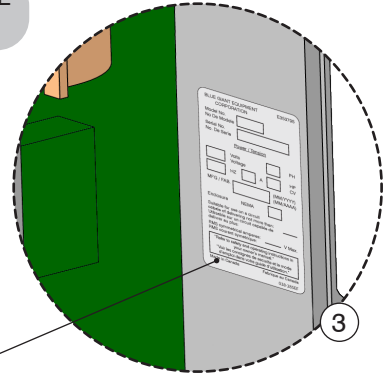

GOLD SERIES III

BLUE GIANT EQUIPMENT CORPORATION E353795

Model No.

No. De Modele

Serial No.

No. De Serie

Power / Tension

Volts PH

Voltage HP

HZ A CV

MFG / FAB. (MM/YYYY)

(MM/AAAA)

Enclosure NEMA

Suitable for use on a circuit cable of delivering not more than: Utilisable sur un circuit capable de délivrer au plus: _____

RMS symmetrical amperes: _____ V Max.

RMS courant symétrique: _____

"Refer to safety and operating instructions in your owner's manual."
"Voir les consignes de sécurité et le mode d'emploi dans votre guide d'utilisation."

Made in Canada Fabriqué au Canada 038-285EF

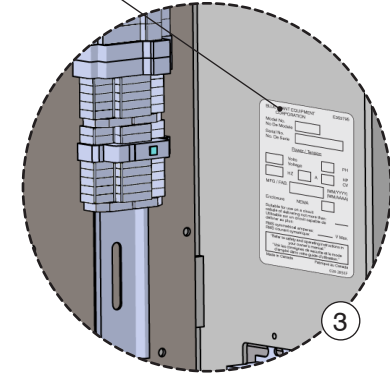

PLATINUM SERIES

ITEM	QTY	PART NO.	*	DESCRIPTION
1	1	038-283E	F S	Decal - Do Not Drill
2	1	038-853E	F S	Decal - Warning
3	1	038-285E	F S	Decal - Serial Plate (Not sold separately)(Located inside control box enclosure)
4	1	038-296E	F S	Decal - Warning Interior Control Box
5	1	Dependent on Model	F S	Decal - Blue Genius Gold Series III (Not sold separately)
6	1	038-400E	F S	Decal - Blue Genius Platinum Series (Not sold separately)

12.0 STOP PROCEDURE: GOLD SERIES III AND PLATINUM SERIES



If dock equipment needs to be stopped immediately, the operator can use the 'STOP' button. Touching the 'STOP' button during operation allows the operator to halt or limit equipment motion in the event of a potential emergency.

When in STOP mode:

- **DO NOT go under the dock leveler**
- **DO NOT walk or drive on lip or deck**
- **DO NOT leave truck or material sitting on the leveler**

1) Touch the 'STOP' button. The control panel light instantly changes to flashing RED and the exterior traffic light will turn RED. The audible alarm will beep until stop mode is exited.

To silence the audible alarm, touch the 'STOP' button a second time as acknowledgement that stop has been activated.



2) "SYSTEM STOPPED, To Continue...Touch and Hold ESC Key" will appear on LCD screen.

Verify surroundings and corrections before exiting stop mode.

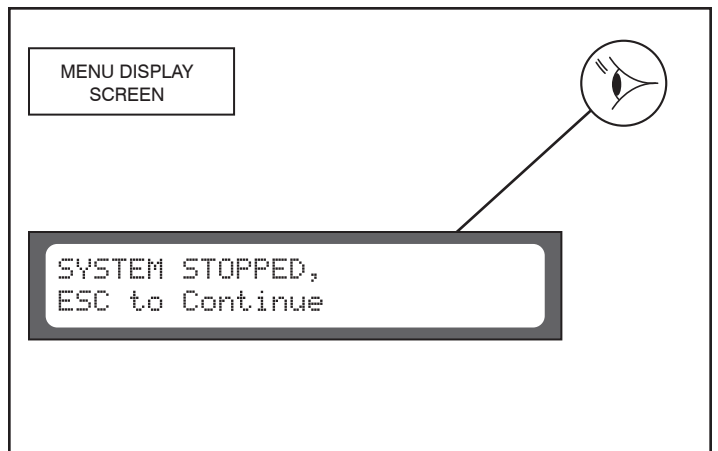

3) To exit stop mode, touch the 'ESC' button. "Please Wait..." will appear on LCD screen.

The system will reset with lights and operation as required.

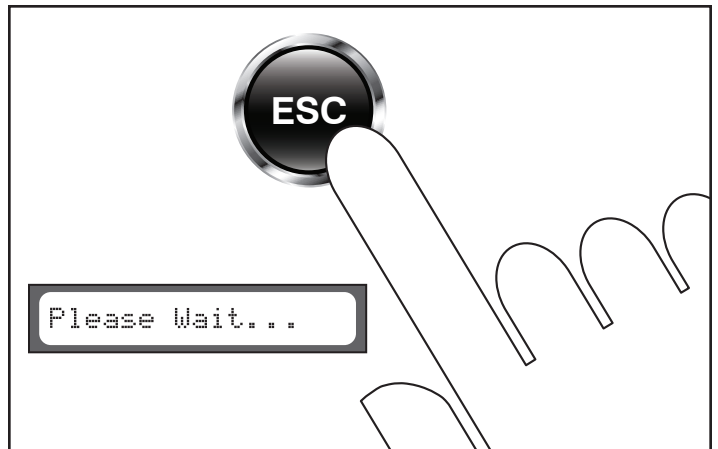

13.0 OPERATING INSTRUCTIONS: GOLD SERIES III AND PLATINUM SERIES

Operating instructions are not always chronological. Perform steps as necessary. The following steps apply to pit-style dock levelers only.

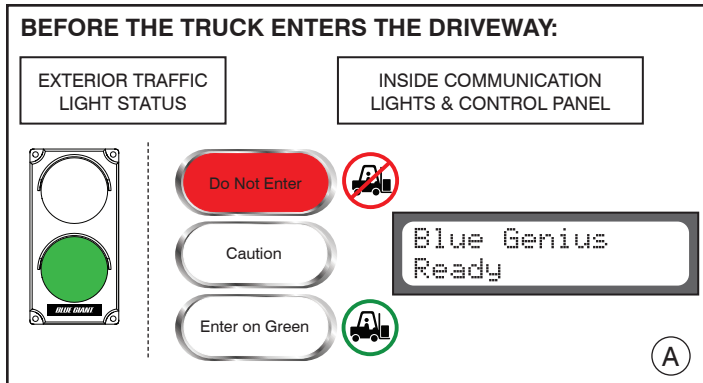

Before the truck enters the driveway, the exterior traffic light will be GREEN and the control panel light will be RED. The screen will read "Blue Genius Ready." The truck may now enter the driveway. This sequence also indicates that it is safe for the truck to leave at the end of loading / unloading.

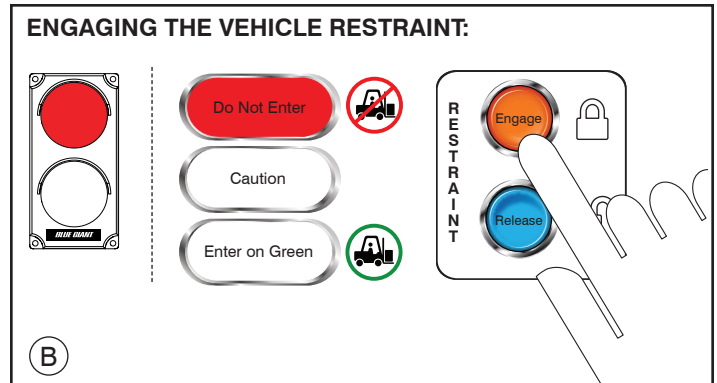

Touch the 'Engage' button to activate vehicle restraint. Exterior traffic light will change to RED. Screen will read "Restraint Engaging." Once the ICC bar is secured, the message will change to "Restraint is Engaged" followed by "Dock Leveler Restored" and "Ready to Raise Deck." If a warning message appears on the screen, see Section 14.0 "Engaging the Override Feature: Gold Series III and Platinum Series."

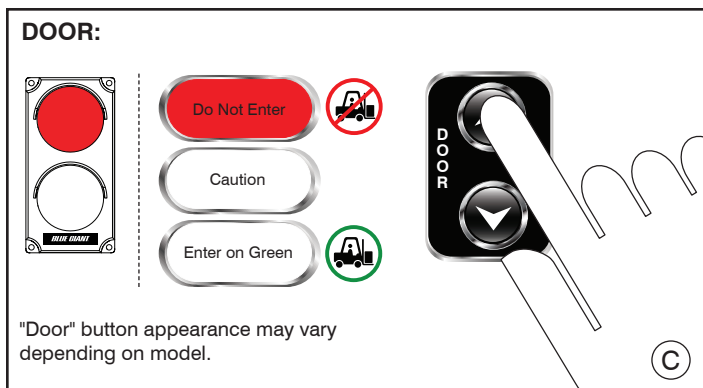

Press the 'OPEN' button to raise the overhead door when the door is not in automatic mode. Screen will read "Door is Opening."

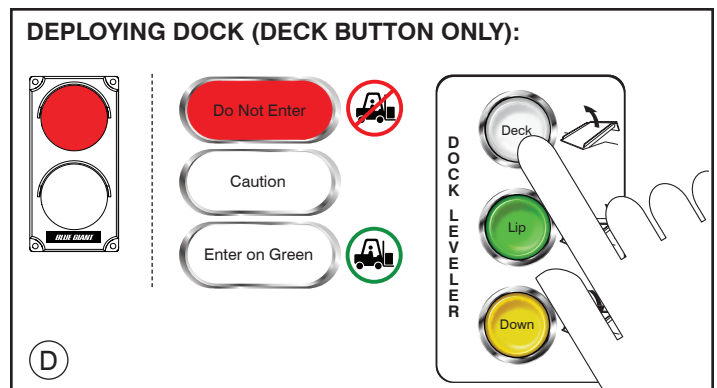

Touch the 'Deck' button. Screen will read "Deck Raising." Hold until lip deploys. Release button. Screen will read "Deck Moving." Dock leveler and lip will descend onto the truck bed. Screen will read "Deck Deployed." Control panel light will turn GREEN. If deploying below level, see Section 13.1 "Alternative Methods of Operation: Gold Series III and Platinum Series."

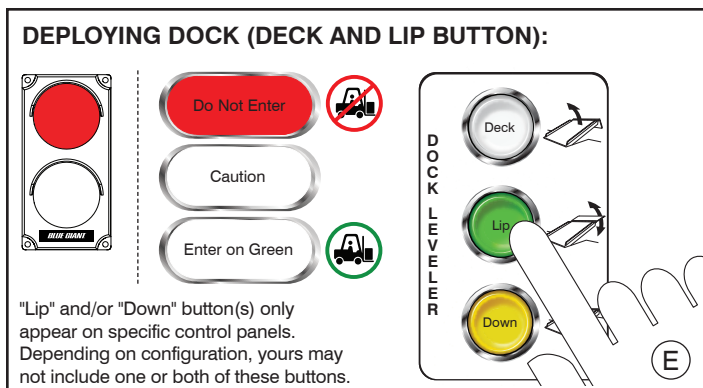

Touch and hold the 'Deck' button. Screen will read "Deck Raising." When the lip has cleared the lip keepers or trailer, release the "Deck" button and touch and hold the 'Lip' button. Screen will read "Lip Moving." Release button. Screen reads "Deck Moving." The leveler and lip will descend to truck bed, message will change to "Deck Deployed". Control panel light will turn GREEN.

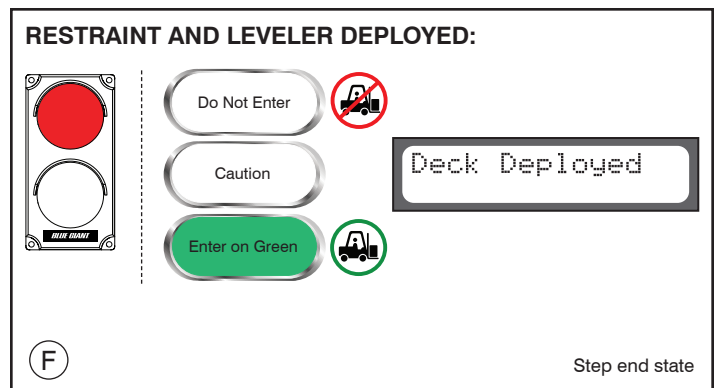

Restraint and leveler deployed correctly. Perform loading and unloading.

13.0 OPERATING INSTRUCTIONS: GOLD SERIES III AND PLATINUM SERIES CONT'D.

PERFORM LOADING AND UNLOADING

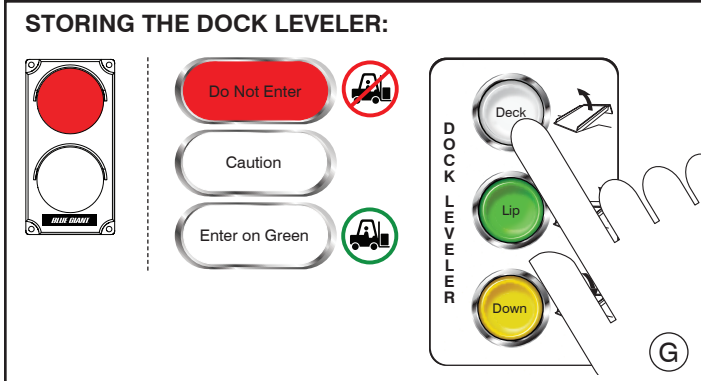

Touch and hold the 'Deck' button. Control panel light will turn RED. The deck will raise and lip will retract. When the lip has fully retracted, release the 'Deck' button. Screen will read "Deck Moving" and the deck will lower to stored position with the lip in the lip keepers. Message will change to "Dock Leveler Restored" followed by "Ready to Release" (refers to vehicle restraint).

NOTE: Following this step, press the 'Close' button on the door controls (see Section 13.0 "Operating Instructions: Gold Series III and Platinum Series", Step C) to lower the overhead door. Screen will read "Door is Closing."

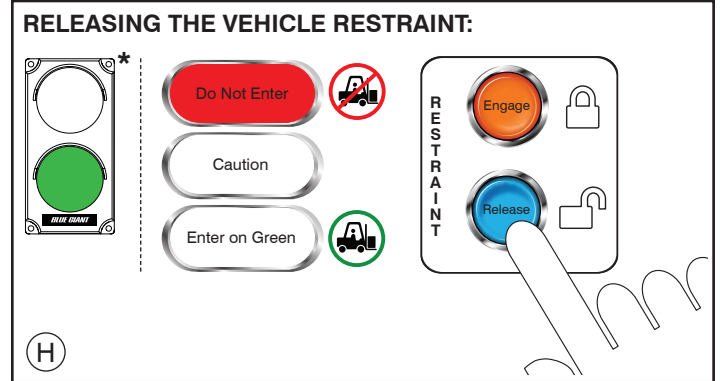

Touch the 'Release' button. Screen will read "Restraint Releasing." When the restraint is in the home position, message will change to "Blue Genius Ready."

* Traffic light will turn GREEN after the restraint is lowered.

13.1 ALTERNATIVE METHODS OF OPERATION: GOLD SERIES III AND PLATINUM SERIES

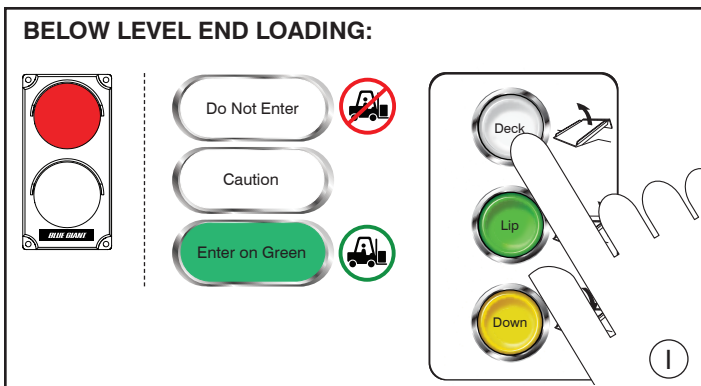

Touch the 'Deck' button. Screen will read "Deck Raising." Hold until lip partially extends. Release 'Deck' button. Screen will read "Deck Moving." The dock leveler and lip will descend. The lip will hang in pendent position between dock face and trailer. Screen will read "Deck Deployed." Control panel light will turn GREEN.

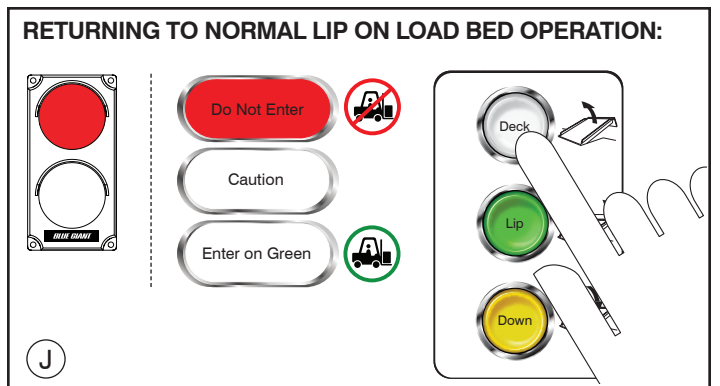

Touch and hold the 'Deck' button until the dock is high enough for the lip to deploy safely onto the load bed. Return to Step F of Section 13.0 "Operating Instructions: Gold Series III and Platinum Series."

14.0 ENGAGING THE OVERRIDE FEATURE: GOLD SERIES III AND PLATINUM SERIES



Should it be necessary to bypass the vehicle restraint function (i.e. the truck has an outdated, damaged, or missing ICC bar), a system-approved override code may be entered via the Blue Genius™ touch keypad. This code can be used whether or not the dock leveler is interlocked with the Blue Genius.™ Ensure that the vehicle is manually chocked before loading and unloading begins.

NOTE: If a visual inspection confirms that the ICC bar is missing or too damaged to be secured then depending on your Blue Genius Software version:

- Up to Version 3.0 (inclusive), bypass Step 1 in the instructions below and go directly to Step 2, which explains how to enter the Override Code.
- From Version 3.1 and higher, step 1 is required sequence and then proceed to step 2, follow the instructions. Alternative sequence processes may be available, please consult your Blue Giant representative.

1. During "Engaging the Vehicle Restraint" (see Section 13.0 "Operating Instructions: Gold Series III and Platinum Series," Step B), the LCD screen may read "ICC Bar Not in Range." This message indicates that a vehicle's ICC bar is absent or cannot be engaged. Determine whether the vehicle needs to be realigned or if wheel chocks are necessary. Press "SEL" to continue.

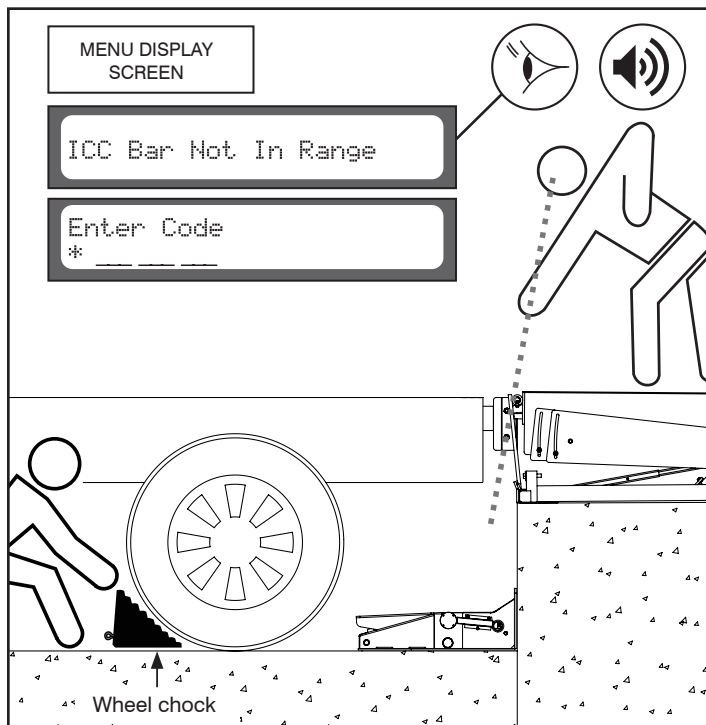

2A. Press the * key on the keypad. The LCD screen will read 'Enter Code * _ _ _ _'.

Enter the supervisor code (default factory set code is '247').

NOTE: The default code can be changed. Please call your Blue Giant representative for further information.

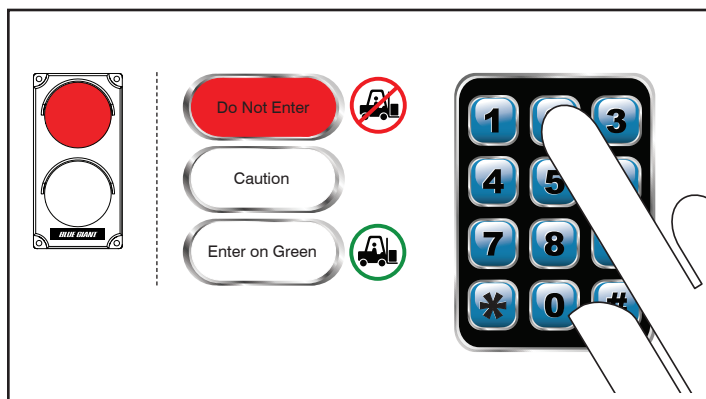

14.0 ENGAGING THE OVERRIDE FEATURE: GOLD SERIES III AND PLATINUM SERIES CONT'D.

Continue operation of overhead door, dock leveler, and vehicle restraint as outlined in Section 13.0 / 13.1 "Operating Instructions: Gold Series III and Platinum Series / Alternative Methods of Operation: Gold Series III and Platinum Series." The following indicators will appear:

2B. The LCD screen will read 'Dock Leveler Restored' and then "Ready to Deploy Deck," followed by "Restraint Is Bypassed."

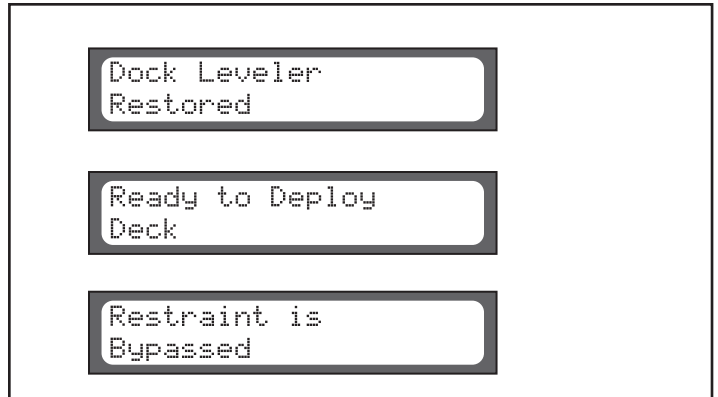

2C. Once the deck is deployed and the home sensor becomes inactive, the control panel light will turn GREEN while flashing YELLOW. This indicates that the vehicle restraint is not engaged.

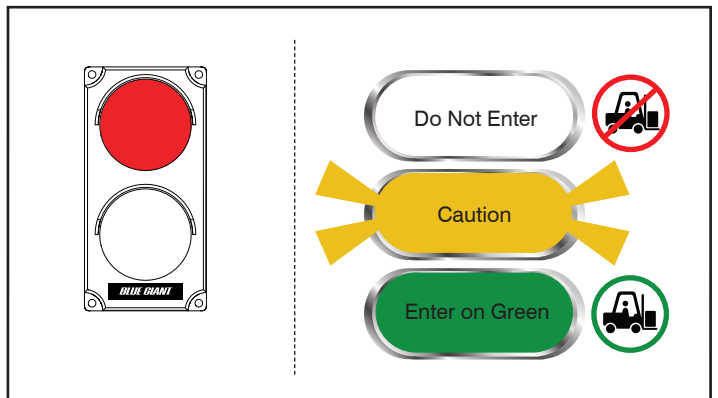

14.1 RELEASING THE OVERRIDE FEATURE: GOLD SERIES III AND PLATINUM SERIES

1. Store the dock leveler. (NOTE: Override is still active when dock leveler and vehicle restraint are in the parked position). The control panel light will turn RED.

Touch the 'Release' button on the control panel to release the override. The control panel will verify that the vehicle restraint has been lowered to the home position. The LCD screen will read "Blue Genius Ready" (see Section 13.0 "Operating Instructions: Gold Series III and Platinum Series," Step H)

The exterior traffic light will turn GREEN, advising the truck driver that it is safe to depart once the wheel chocks are removed.

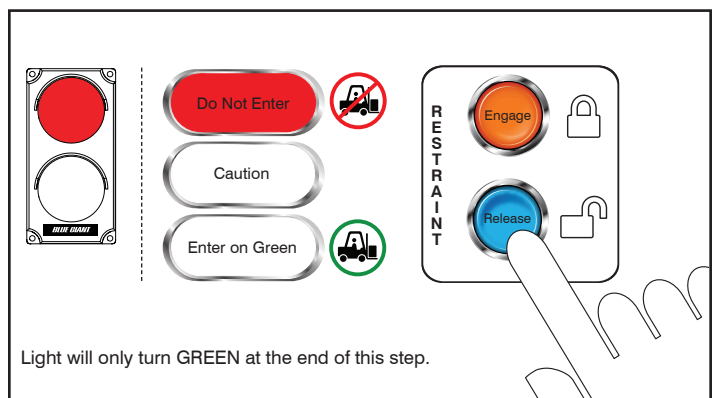

15.0 EXTERIOR TRAFFIC LIGHT / MIRROR SIGN IMAGE: GOLD SERIES III AND PLATINUM SERIES



The LED traffic lights and mirror image drive warning sign improve loading dock safety.

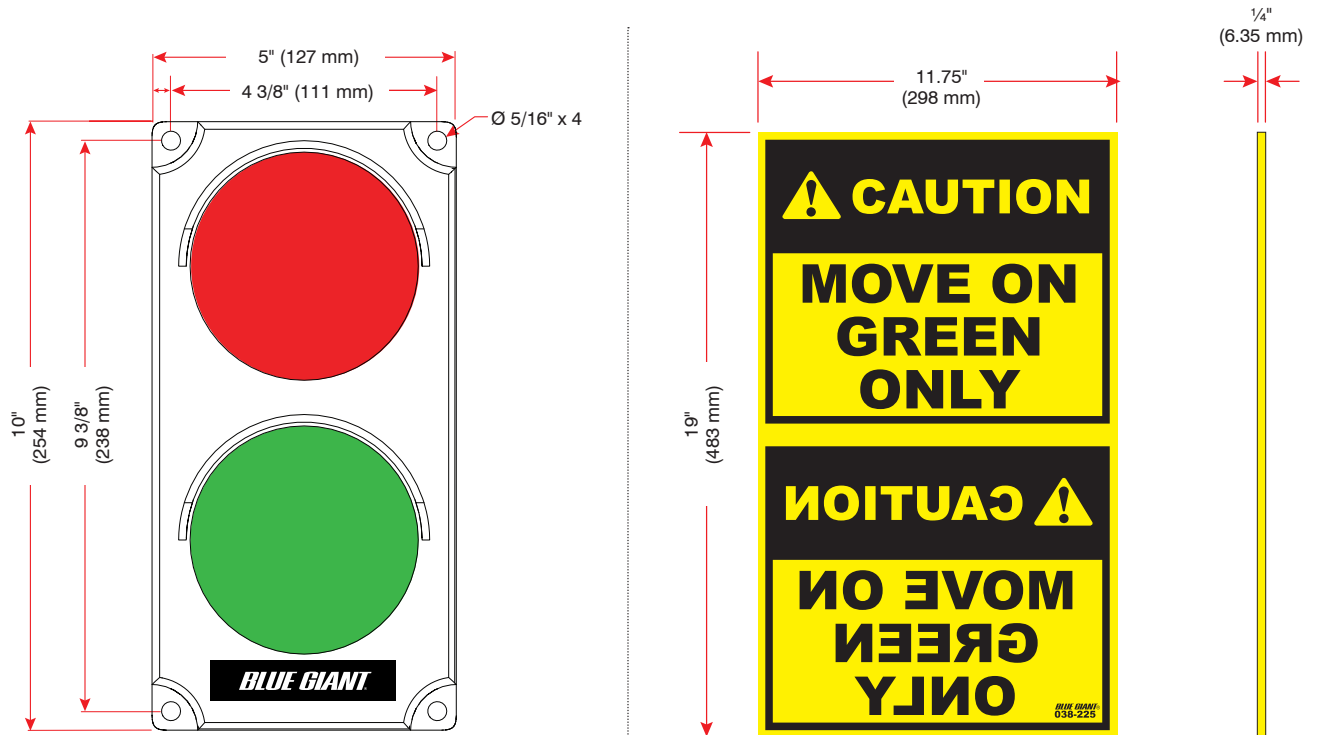

Exterior driver traffic light, part # 032-806.

NOTE: Mount to a flat surface. DO NOT deform light housing with irregular wall surface.

Exterior driver warning sign, part # 038-225.
(French 038-225F / Spanish 038-225S / Portuguese 038-225P)

16.0 CONTROL PANEL LCD MESSAGES: GOLD SERIES III AND PLATINUM SERIES



WARNING

Do not attempt to install, make repairs or adjustments. Only a trained and authorized service technician should perform the installation process. Contact your local dealer or distributor for assistance.

MESSAGE	EXPLANATION
<p>'Fault 31' IPS sensor value too low</p>	<ol style="list-style-type: none"> 1. IPS shaft not secured by set screw, tighten set screw making sure the IPS green LED light is lit with the restraint arm in its lowered position. NOTE: the set screw does not tighten down on the flat of the IPS shaft. 2. IPS not programmed. See set-up procedure.
<p>During self test mode the following message appear: 'Remote I/O Bad' 'Positioner Bad'</p>	<ol style="list-style-type: none"> 1. Faulty wiring, communication cable not connected or damaged. 2. Circuit board faulty.
<p>'Please restore Dock Leveler'</p>	<ol style="list-style-type: none"> 1. Restraint interlock sensor (home/lip) is in-active, out of range. 2. Restraint interlock sensor (home/lip) is not connected. 3. Faulty wiring. 4. Dock not in stored/home position.
<p>'ICC Bar not in Range'</p>	<ol style="list-style-type: none"> 1. Restraint arm went up and did not find ICC bar in preset range. 2. IPS not programmed.
<p>'Fault 10' Communication error</p>	<ol style="list-style-type: none"> 1. Faulty wiring, check for loose or broken communication cable wire(s). 2. Noise interference, check routing of communication from Blue Genius™ controls to remote devices.
<p>'Restraint Arm Blocked' Followed by: 'Restore Restraint, press 'SEL' to continue, Blue Genius™ Warning' (repeats)</p>	<ol style="list-style-type: none"> 1. Restraint arm failed to lower all the way down. Check for debris. 2. Faulty IPS board or switches. 3. Faulty wiring.
<p>'Restraint is Engaged' Followed by: 'Dock Leveler Restored', 'Ready to Deploy Deck'. (repeats)</p>	<ol style="list-style-type: none"> 1. The 'Engage' button has been touched and vehicle restraint is in locked position.
<p>During self test mode the following message appears: 'Remote I/O Bad'</p>	<ol style="list-style-type: none"> 1. Faulty wiring, check communication cable wires for loose connections. 2. Remote I/O is faulty, replace. 3. Blue Genius™ power board is faulty, replace.
<p>During self test mode the following message appears: 'Positioner Bad'</p>	<ol style="list-style-type: none"> 1. Faulty wiring, check communication cable wires for loose connections. 2. IPS board is faulty, replace. 3. Blue Genius™ power board is faulty, replace.
<p>'Restraint fault - COMB - Main power'</p>	<ol style="list-style-type: none"> 1. Change F3. Not F1.

17.0 WIRING DIAGRAMS: GOLD SERIES III AND PLATINUM SERIES



NOTICE

The following wiring diagrams are sample configurations only. Wiring diagrams specific to your needs will be provided inside the control panel and/or as part of your submittal package.

17.1 WIRING DIAGRAM—115V SINGLE PHASE: GOLD SERIES III (SVR303 & FH COMBO)

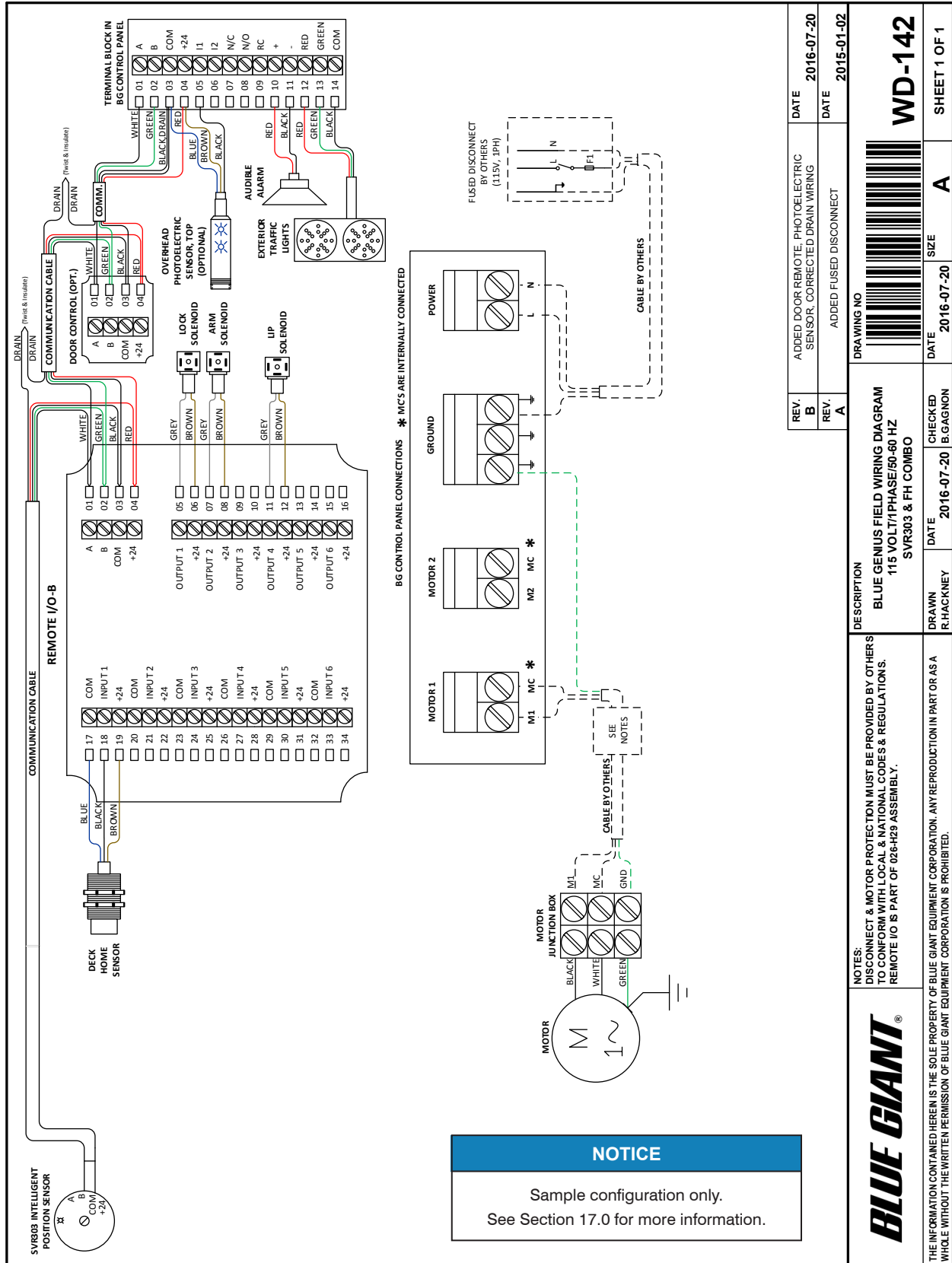

REV. B	ADDED DOOR REMOTE PHOTOELECTRIC SENSOR, CORRECTED DRAIN WIRING	DATE	2016-07-20
REV. A	ADDED FUSED DISCONNECT	DATE	2015-01-02

DESCRIPTION

BLUE GENIUS FIELD WIRING DIAGRAM
115 VOLT/1PHASE/50-60 HZ
SVR303 & FH COMBO

DRAWING NO.

WD-142

NOTES:

DISCONNECT & MOTOR PROTECTION MUST BE PROVIDED BY OTHERS TO CONFORM WITH LOCAL & NATIONAL CODES & REGULATIONS. REMOTE IO IS PART OF 026-H23 ASSEMBLY.

THE INFORMATION CONTAINED HEREIN IS THE SOLE PROPERTY OF BLUE GIANT EQUIPMENT CORPORATION. ANY REPRODUCTION IN PART OR AS A WHOLE WITHOUT THE WRITTEN PERMISSION OF BLUE GIANT EQUIPMENT CORPORATION IS PROHIBITED.

BLUE GIANT®

DRAWN	R. HACKNEY	DATE	2016-07-20	CHECKED	B. GAGNON
SIZE	A	DATE	2016-07-20	SHEET	1 OF 1

17.2 WIRING DIAGRAM—230V SINGLE PHASE: GOLD SERIES III (TL85 REMOTE & FH COMBO)

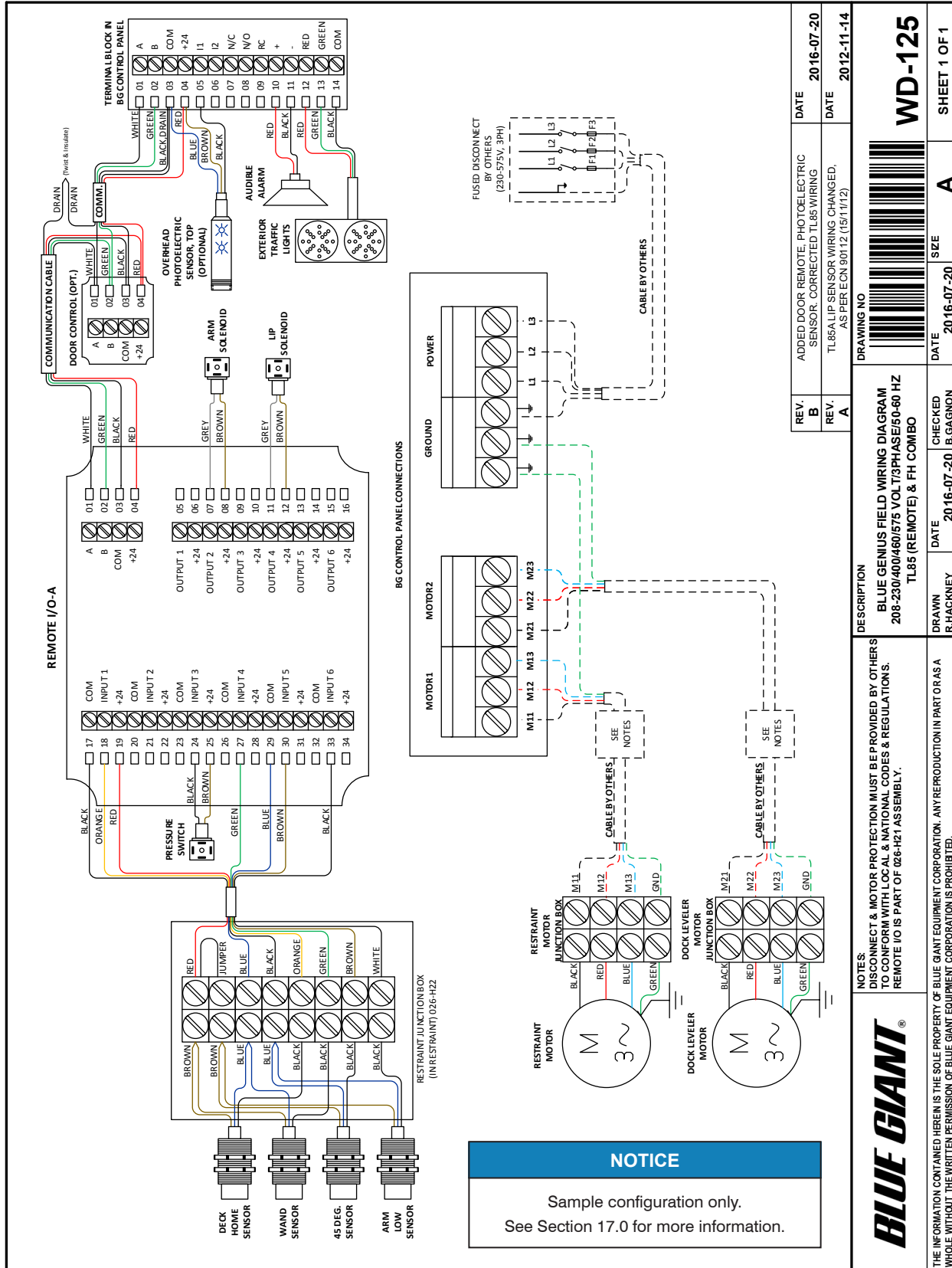

17.3 POWER WIRING DIAGRAM - 230 - 575V THREE PHASE: PLATINUM SERIES* (SVR303 & VL COMBO)

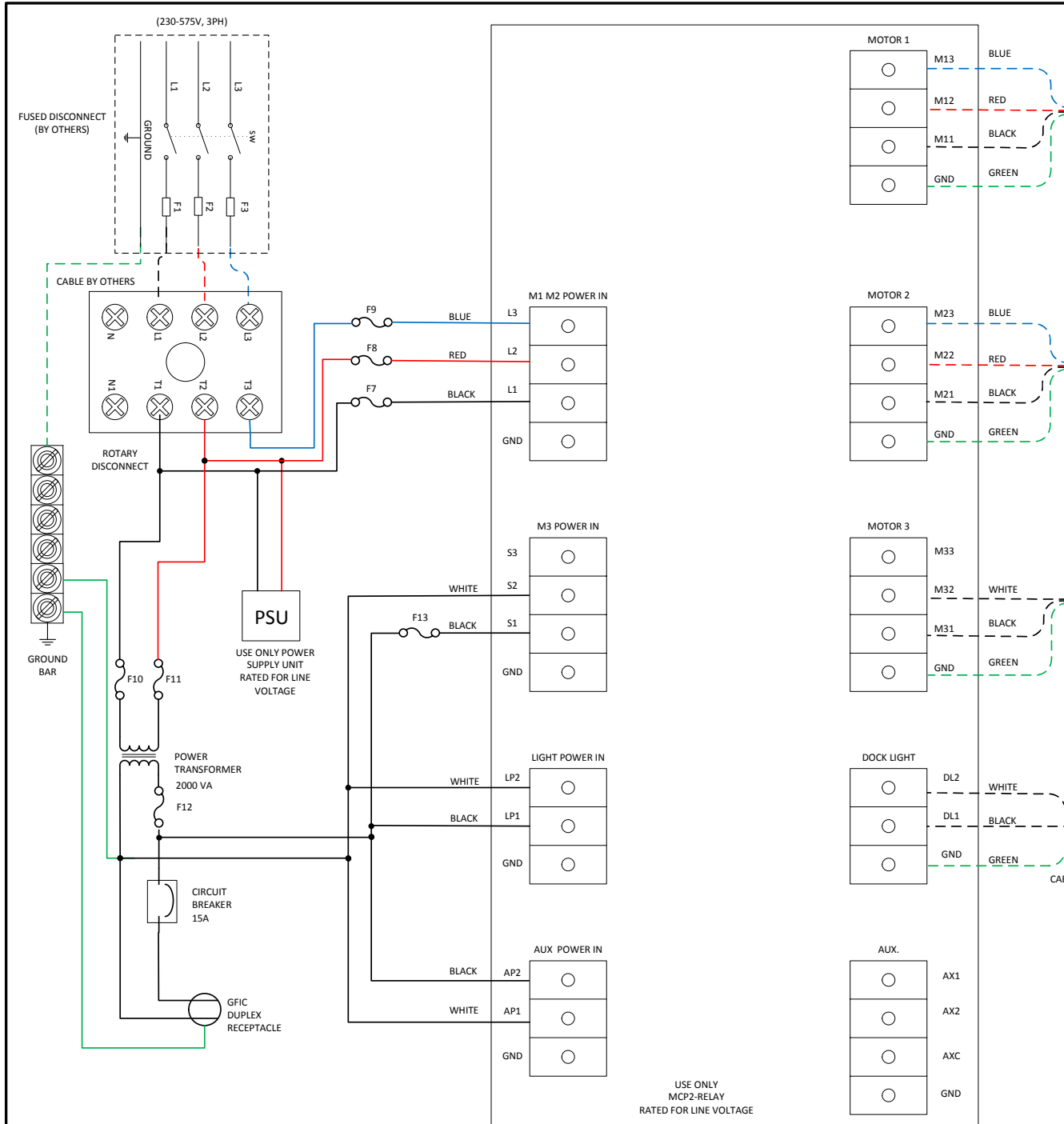

5	026-RB3575-BGP-3PSH	RELAY BOARD ASSY, 575V, 3PH SHELTER	575V, 3PH/ 115-230V, 1PH
4	026-RB3575-BGP	RELAY BOARD ASSY, 575V, 3PH	575V, 3PH/ 115-230V, 1PH
3	026-RB3575-BGP	RELAY BOARD ASSY, 460V, 3PH	460V, 3PH/ 115-230V, 1PH
2	026-RB3575-BGP	RELAY BOARD ASSY, 400V, 3PH	400V, 3PH/ 115-230V, 1PH
1	026-RB3230-BGP	RELAY BOARD ASSY, 230V, 3PH	230V, 3PH/ 115-230V, 1PH
ITEM	PART NO.	DESCRIPTION	MAIN SUPPLY/ SECONDARY SUPPLY

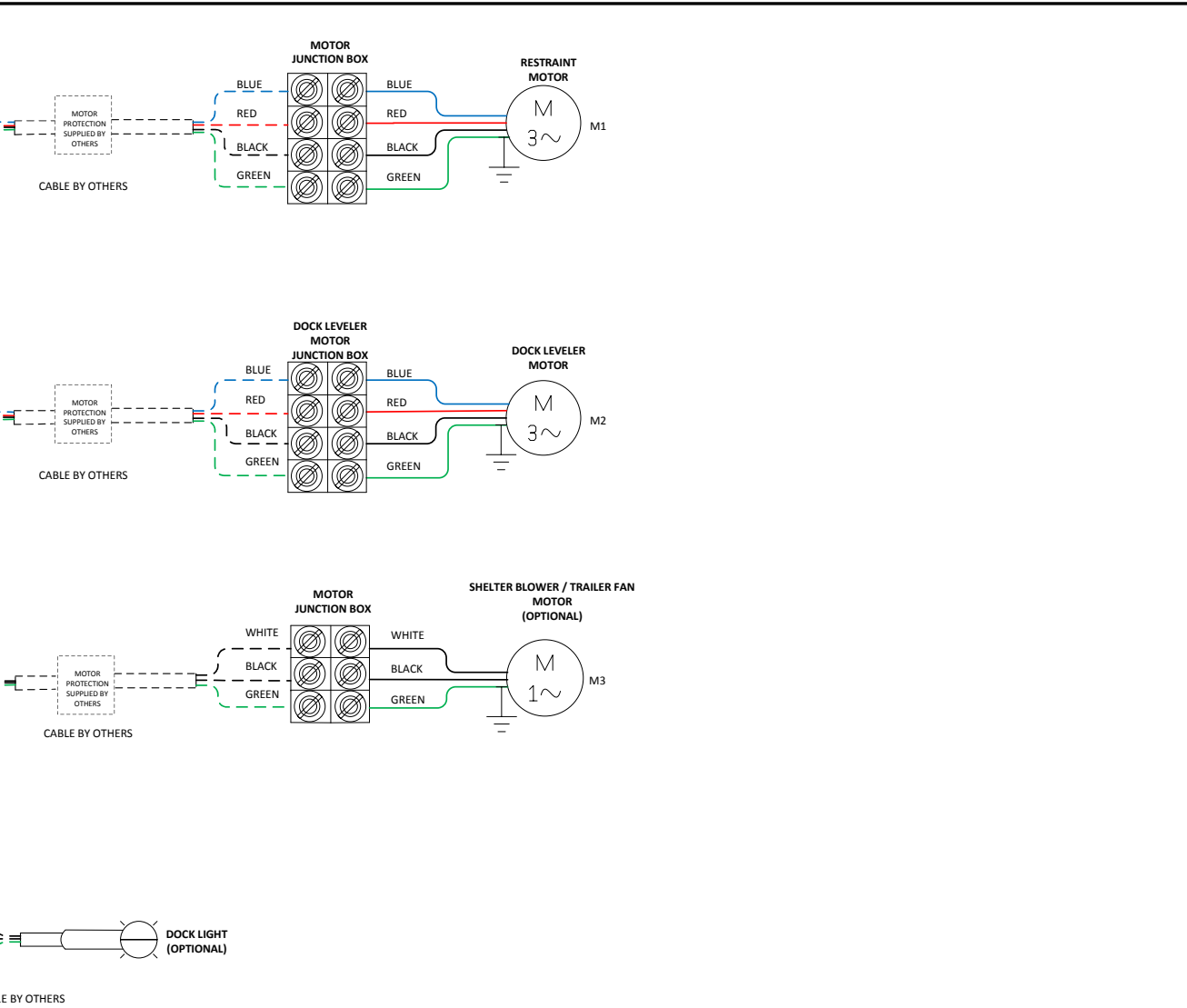

NOTICE

Sample configuration only.
See Section 17.0 for more information.

THE INFORMATION CONTAINED HEREIN IS THE SOLE PROPERTY OF BLUE GIANT EQUIPMENT CORPORATION. ANY REPRODUCTION IN PART OR AS A WHOLE WITHOUT THE WRITTEN PERMISSION OF BLUE GIANT EQUIPMENT CORPORATION IS PROHIBITED.

NOTES:
DISCONNECT & MOTOR PROTECTION MUST BE PROVIDED BY OTHERS TO CONFORM WITH LOCAL & NATIONAL CODES & REGULATIONS.

DRAWN B Gagnon	DATE 2016-01-08
CHECKED K Manro	DATE 2016-01-08

BLUE GIANT®

DESCRIPTION **BLUE GENIUS PLATINUM FIELD WIRING DIAGRAM**
230/400/460/575 VOLT/3-PHASE/50-60 HZ SVR + VL COMBO
OPTIONS: 15A TRANSFORMER

SIZE B	DRAWING NO WD-331
SCALE NONE	WEIGHT NA
SHEET 1 OF 2	

*For 230/400/460/575V 3PH 50-60HZ input power.

17.4 CONTROL WIRING DIAGRAM - 230 - 575V THREE PHASE: PLATINUM SERIES (SVR303 & VL COMBO)

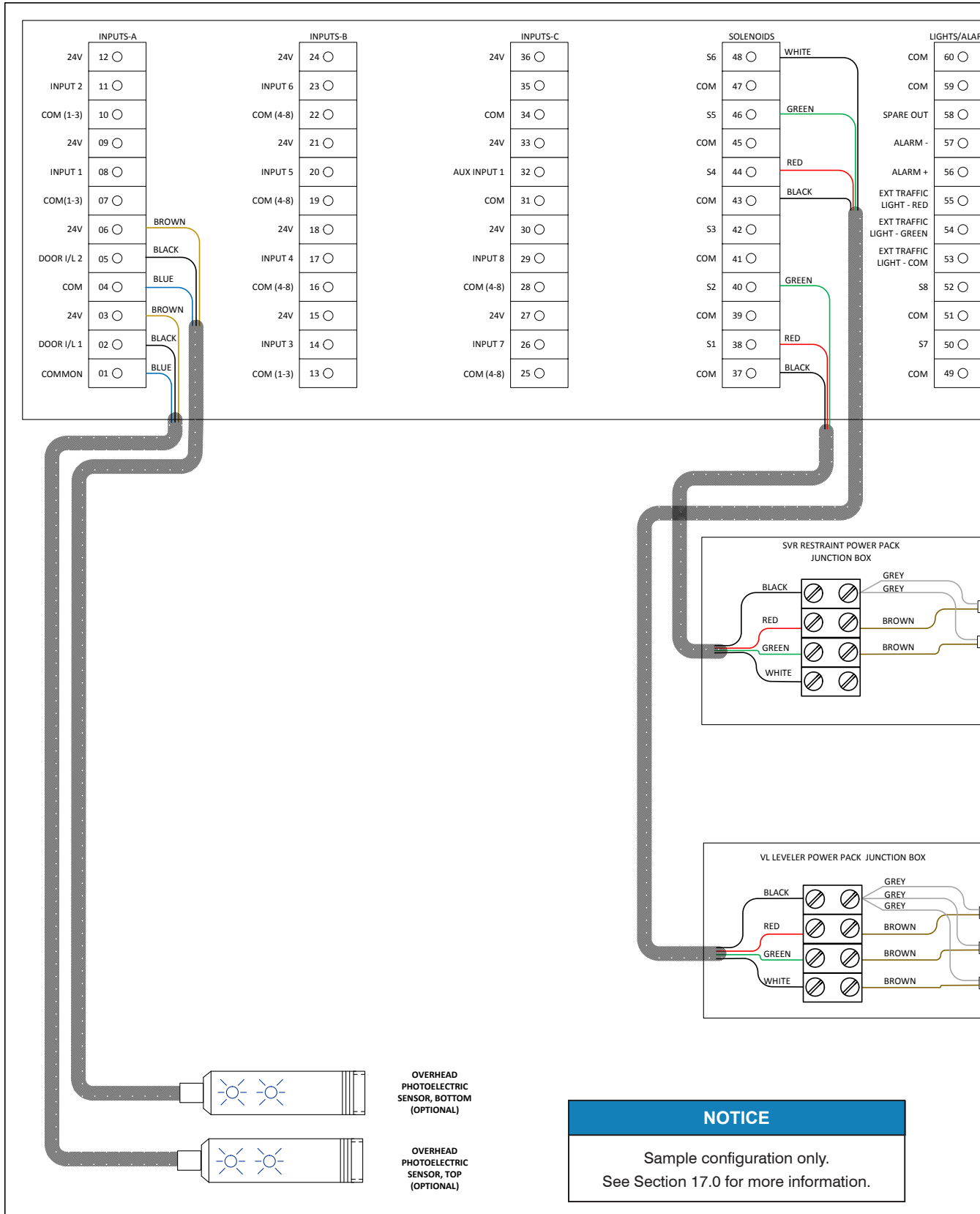

NOTICE

Sample configuration only.
See Section 17.0 for more information.

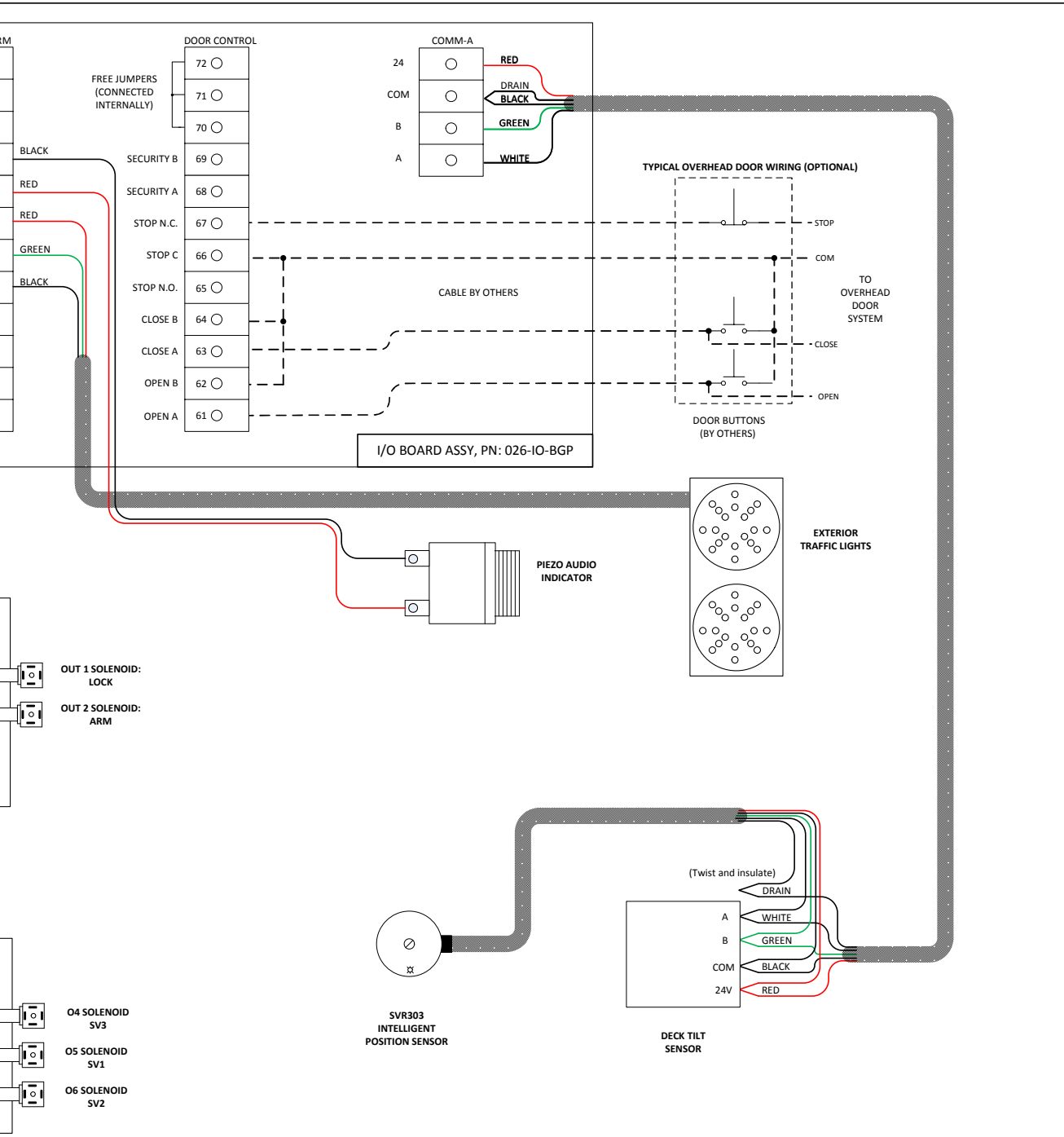

THE INFORMATION CONTAINED HEREIN IS THE SOLE PROPERTY OF BLUE GIANT EQUIPMENT CORPORATION. ANY REPRODUCTION IN PART OR AS A WHOLE WITHOUT THE WRITTEN PERMISSION OF BLUE GIANT EQUIPMENT CORPORATION IS PROHIBITED.

NOTES:
DISCONNECT & MOTOR PROTECTION MUST BE PROVIDED BY OTHERS TO CONFORM WITH LOCAL & NATIONAL CODES & REGULATIONS.

BLUE GIANT®

DESCRIPTION **BLUE GENIUS PLATINUM FIELD WIRING DIAGRAM**
230/400/460/575 VOLT/3-PHASE/50-60 HZ SVR + VL COMBO
OPTIONS: 15A TRANSFORMER

DRAWN	B Gagnon	DATE	2016-01-08
CHECKED	K Manro	DATE	2016-01-08

SIZE	B	DRAWING NO	WD-331
SCALE	NONE	WEIGHT	N/A
			SHEET 2 OF 2

BLUE GIANT[®]
BLUE GIANT EQUIPMENT CORPORATION

Corporate 410 Admiral Blvd.
Mississauga, ON, Canada L5T 2N6
t 905.457.3900 f 905.457.2313

USA 6350 Burnt Poplar Road
Greensboro, NC 27409
www.bluegiant.com