

**BLUE GIANT<sup>®</sup>**

# HYDRAULIC DOCK LEVELER

**LOAD USAGE**

Up to 40,000 lb  
(18,143 kg)

**LOAD CLASS**

Workhorse  
Heavy  
Super  
Extreme  
Ultra

**NEXT  
GEN**



Designed for demanding applications.  
Delivering maximum efficiency and performance.



**A**  
**Clean Frame Design**  
 Allows for easy pit cleaning and reduces trapped debris.

**B**  
**One Piece Dock Strut**  
 Updated design provides increased stability and lessens the likelihood of movement due to vibration.

**C**  
**Full Operating Range Toe Guards**  
 Reduce the risk of foot-related injuries at the loading dock.

**D**  
**Solid Structure**  
 Solid headboard and rear frame enhance unit stability.

**E**  
**Enhanced J-Beams Channels**  
 High-tensile steel beams allow the deck to flex without distorting over time.

**F**  
**Fully Hydraulic Operation**  
 Deck and lip cylinders provide the best in class operation. Full range at the touch of a button.

**G**  
**Velocity Fuse**  
 Reduces fall distance in the event of premature truck departure.

# OVERVIEW +FEATURES

## EASY TO OPERATE

- Fully hydraulic deck and lip operation eliminates the need for manual deployment.
- The NEMA4X single push-button control station enables sequenced deck and lip operation.
- Maximize unit versatility with optional independent lip control that drastically reduces cycle time and energy use—perfect for below level or end-loading applications (requires Blue Genius™ Touch Control Panel).

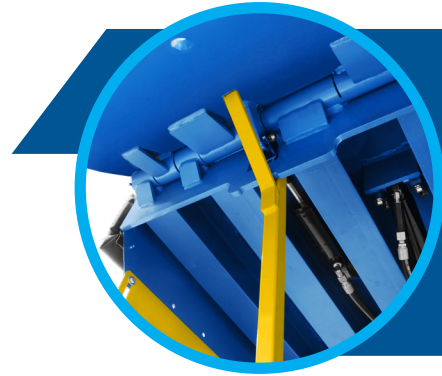
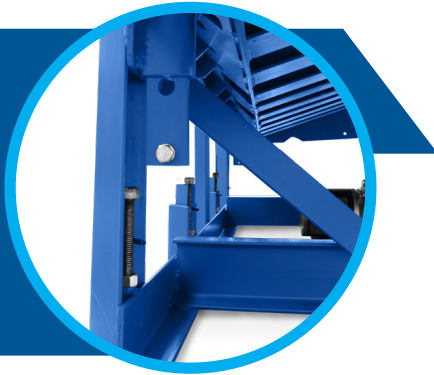

## STRUCTURAL INTEGRITY

- 8-10 enhanced J-beam channels are welded to the underside of the deck at dynamic impact points to prevent distortion and extend the lifetime of the dock leveler.
- All dock options, including 6', 6'-6", and 7', are designed to accommodate both four-wheel and three-wheel forklifts as standard.
- The continuous one-piece headboard and single lip hinge pin enhance unit stability, enabling a stronger distributed load.
- Notched headboard and base frame provide increased stability for service equipment, such as the dock strut and service stand.
- High tensile deck and lip provide maximum structural integrity.

## DECK FLEX ADVANTAGE

- Ideal for normal loading conditions, the fixed rear hinge design allows the deck to flex up to 4" (102 mm) when under load to ensure full-width contact between the lip and the truck bed.
- The deck remains flush with the floor to eliminate pinch points and cross traffic obstruction.



## BUILT FOR SAFETY

- In the unlikely event of premature truck departure, the velocity fuse limits free-fall of a loaded platform to a maximum of 3" (76 mm).
- One piece dock strut settles firmly into vertical position, supporting both deck and lip for safe under-deck maintenance and pit maintenance.
- Optional powder coat grit finish reduces the likelihood of slipping on the deck in wet conditions.
- Stationary side toe guards with high-visibility OSHA safety striping and safety yellow full operating range metal toe guards reduce the risk of foot-related injuries at the loading dock.

## ADVANCED ENGINEERING

- The inverted deck cylinder is continually self-bleeding, reducing internal corrosion and improving velocity fuse efficiency.
- The velocity fuse has no limits on performance frequency. Dock operation can resume after the condition that activated the velocity fuse is corrected.
- Equipped with a NEMA4X control station (moisture and corrosion resistant), the Hydraulic Dock Leveler is an ideal solution for special-use facilities, such as refrigerated warehouses and chemical processing plants.
- High tensile J-beams allow the deck to flex side to side while maintaining back to front rigidity without distorting.

## INNOVATION AND QUALITY

- An North American industry-first, the Blue Giant Hydraulic Dock Leveler features a powder coat finish as standard, providing unrivaled longevity to finish and color.
- State-of-the-art robotic welding ensures structural integrity and uniform quality.

# DESIGN

## LEVELER SELECTION - LOAD CLASSIFICATION

### TOTAL LOAD

LOAD WEIGHT + VEHICLE WEIGHT



≤ 5MPH

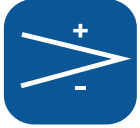

≤ 7% DECK GRADE

### DAILY USAGE

FULL TRUCK (FTL) / CYCLES

FULL TRUCK (FTL)	CYCLES
0-8	0-200
9-16	201-400
17-24	401-600
≥ 24	≥ 600

FULL TRUCK = 24-26 PALLETS

### LOAD CLASS

LOAD + USAGE

- WORKHORSE
- HEAVY
- SUPER
- EXTREME
- ULTRA

LOAD USAGE  
 MAX 40,000 LB

To determine your optimal loading dock solution, contact a Blue Giant sales representative with your total load and daily usage data.

## PIT DIMENSIONS

NOMINAL SIZE		PIT WIDTH (W)		PIT LENGTH (L)	
		in	mm	in	mm
6' x 6'	1829 x 1829mm	74	1880	63	1600
6' x 8'	1829 x 2438mm			87	2210
6' x 10'	1829 x 3048mm			111	2819
6' 6" x 6'	1981 x 1829mm	80	2032	63	1600
6' 6" x 8'	1981 x 2438mm			87	2210
6' 6" x 10'	1981 x 3048mm			111	2819
7' x 6'	2133 x 1829mm	85	2159	63	1600
7' x 8'	2133 x 2438mm			87	2210
7' x 10'	2133 x 3048mm			111	2819

Standard Pit Depth: Front (H): 20" (508mm) Rear (H1): 19.5" (495mm)

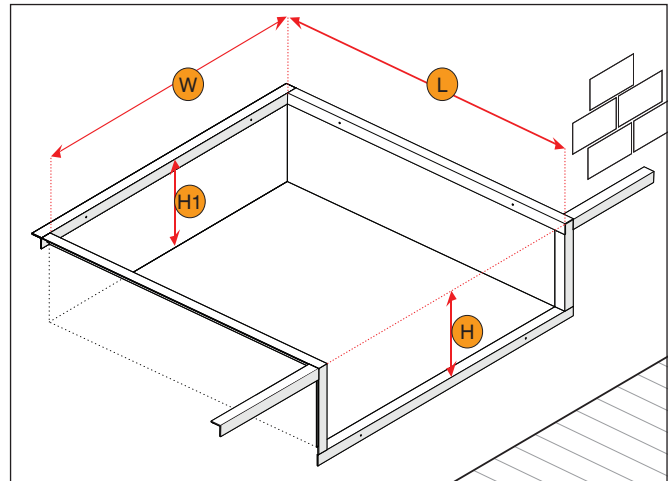

Model Number Ordering Format: H - SIZE - CLASS

Sample Order: Hydraulic - 6' x 6' - Workhorse

Sample Model Number: H6006W

## COLOUR OPTIONS

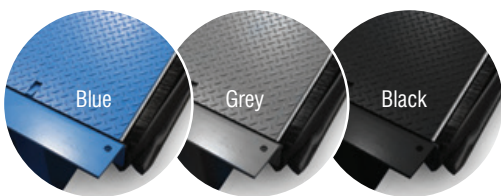

## OPTIONS

- Lip Length 16" (406 mm) Standard 18" (457 mm) or 20" (508 mm)
- No-Shim™ dock frame
- Energy Seal Plus™
- Biodegradable oil, Arctic oil
- Assured Motion Float (floating rear hinge)
- Blue Genius™ Touch Control Panel
- Remote Powerpack
- DLB (Dock Lip Barrier)
- Closed Pit Dock Frame
- Grease Fitting on Lip Tube



Complete powder coat system prolongs the life of your dock equipment. This process is proven to be an effective rustproof solution which creates a safer work environment.

AUTHORIZED DEALER

Corporate 410 Admiral Blvd  
Mississauga, ON, Canada L5T 2N6  
905.457.3900 f 905.457.2313

USA 6350 Burnt Poplar Road  
Greensboro, NC 27409  
www.bluegiant.com

Blue Giant offers a full line of dock levelers, dock safety equipment, seals and shelters, accessories, ergonomic and scissor lift equipment and industrial trucks. Concurrent with our continuing product improvement program, specifications are subject to change without notice. Please contact Blue Giant for latest information. Some features illustrated may be optional in certain market areas.

If calling within North America: t 1.800.872.2583 f 1.888.378.5781

DL-HYD-011425 © Copyright Blue Giant Equipment Corporation 2025